

ANALYSIS
PREPARED BY
CHECKED BY
REVISED BY

CONSOLIDATED VULTEE AIRCRAFT CORPORATION
SAN DIEGO DIVISION

PAGE
REPORT NO
MODEL
DATE

INSPECTED

PROPOSED DEVELOPMENT PROGRAM
ON
ROCKET TYPE MISSILES
REPORT NO. ZP-48-35003

**DOWNGRADED AT 3 YEAR INTERVALS
DECLASSIFIED AFTER 12 YEARS DECLASSIFIED
EOD DR 5200.10**

17

PROPOSED DEVELOPMENT PROGRAM
ON
ROCKET TYPE MISSILES

REPORT NO. ZP-48-35003

SECRET

CONSOLIDATED VULTEE AIRCRAFT CORPORATION
SAN DIEGO CALIFORNIA

NOTICE

THIS DOCUMENT CONTAINS INFORMATION
AFFECTING THE NATIONAL DEFENSE OF THE
UNITED STATES WITHIN THE MEANING OF
THE ESPIONAGE ACT 50 U.S.C., 31 AND
32 , AS AMENDED. ITS TRANSMISSION OR
THE REVELATION OF ITS CONTENTS IN ANY
MANNER TO AN UNAUTHORIZED PERSON IS
PROHIBITED BY LAW.

INTRODUCTION

It is felt that sufficient advancement has taken place in the development of theories, techniques and components required for the design and construction of rocket type missiles to warrant the reconsideration of this type of missile for a major place in the USAF guided missile program.

Some of these developments are as follows:

1. A rocket-powered, self-launched, mechanically stabilized missile has been completed and has made two consecutive, successful flights.
2. The principles of swiveling rocket motors for missile control has been proven in these flights. This principle allows use of high temperature advanced fuels and long burning times required for long ranges.
3. Rocket motors using existing fuels have been developed and tested in sizes practical for tactical use.
4. A guidance system has been developed for this type missile which has possibilities of placing a warhead within a radius of a mile of a given target at a range of 5,000 miles. Breadboard components of this system have been built and tested in a conventional airplane and have developed accuracies of one mill (one mile in a thousand) at a range of 150 miles operating under the disadvantage of flying close to the earth's surface. This system has shown sufficient promise to be chosen as the initial guidance phase for other "in the atmosphere" missiles. While with "in the atmosphere" missiles additional guidance is required (such as star tracking, etc.) this is the sole guidance required for the ballistic type missile.
5. Considerable progress has been made in the development of ceramic materials which are capable of withstanding severe thermal shock at the high temperatures encountered in re-entry into the atmosphere from a very long range ballistic trajectory. (These are not required for ranges up to approximately 1500 miles).
6. Progress is being made in the development of fuels with high specific impulse missiles. (Considerably more emphasis is needed in this field however).

INTRODUCTION (Cont'd)

7. Structural design principles based on structural strength for re-entry of the warhead only and not for re-entry of the entire missile into the atmosphere along with the warhead (as was the case with the V-2) have advanced to the point where it is now possible to design tactical rocket type missiles using present day fuels that are more economical than other type missiles now under consideration.
8. Trajectory studies for rocket powered wingless missiles, carried out under other USAF projects, indicate that ranges more than twice as great as those indicated using a ballistic trajectory, may be obtained for any given mass ratio if a maximum L/D glide path is followed. This principle is a refinement of the ballistic trajectory principle calling for additional guidance and greater refinement of aerodynamics and structures which may be attained in time. The ballistic type missile is the first step towards attaining this ultimate goal.

ANALYSIS
PREPARED BY
CHECKED BY
REVISED BY

CONSOLIDATED VULTEE AIRCRAFT CORPORATION

SAN DIEGO DIVISION

SECRET

PAGE 3

REPORT NO ZP-40-35003

MODEL

DATE NOV. 23, 1948

DEVELOPMENT PROGRAM

WARHEAD EJECTION

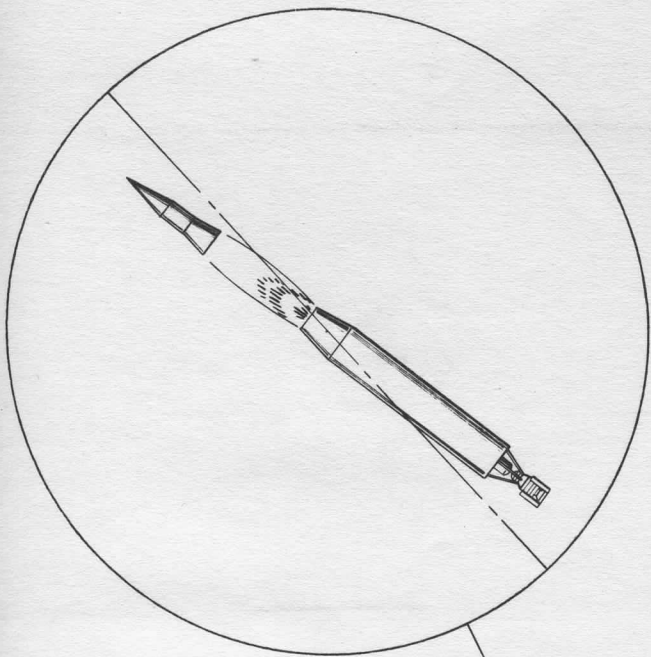

BOOSTER STAGE SEPARATION

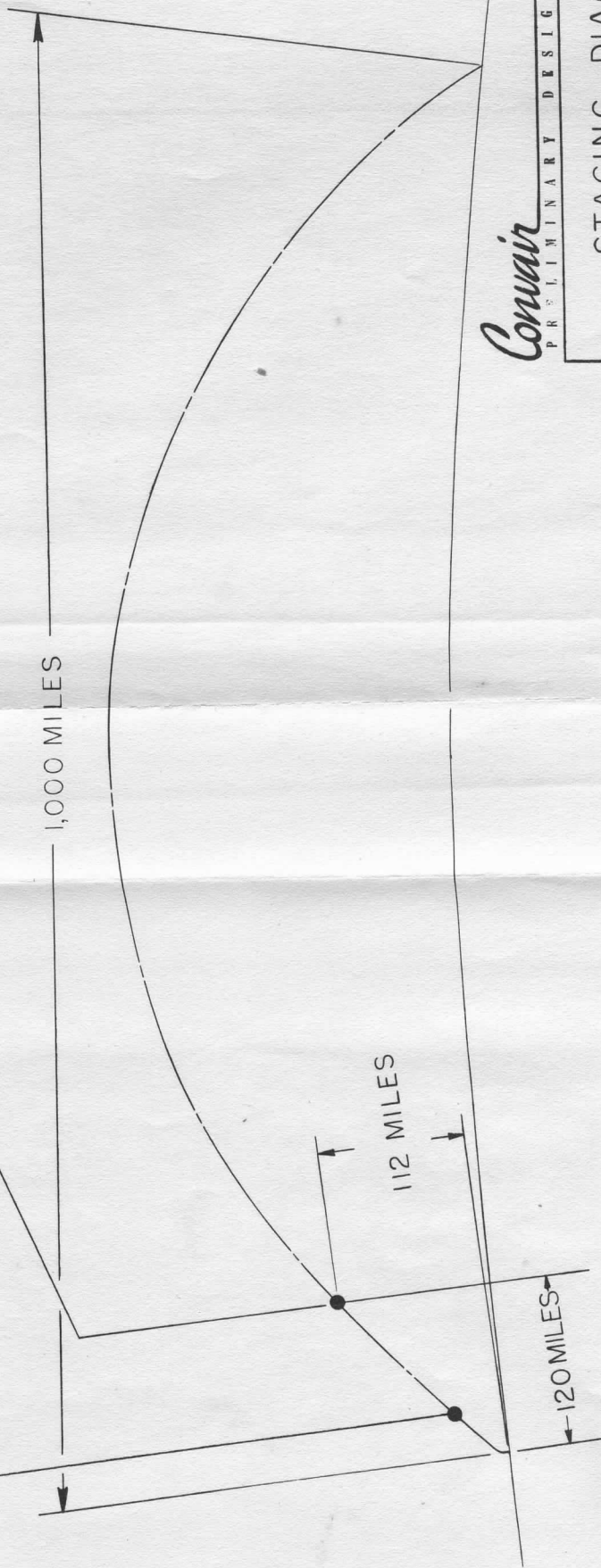
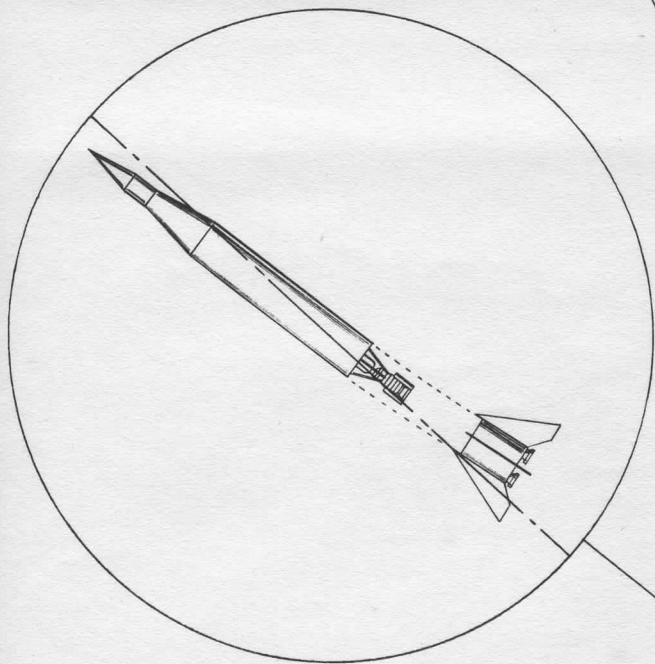

Conair

SECRET

PRELIMINARY DESIGN DRAWING

STAGING DIAGRAM

6,000 LB. WARHEAD 1,000 MILE MISSILE

BY S. B. [signature] CHECKED [signature] APPROVED [signature] DATE 10-25-55
 CONAIR INCORPORATED, 1111 WEST AIDEN AVENUE CORPORATION CD 48 75 005

DEVELOPMENT PROGRAM

As a first step in a program leading to the development of long-range rocket type missiles, it is proposed that emphasis be placed on a design which will carry a 6000 lb. warhead to the maximum range obtainable with present day power plants.

The maximum thrust obtainable from an individual rocket cylinder available today is 20,000 lbs. Practical combination of these cylinders into a total power plant leads to a maximum thrust of 108,000 lbs. This thrust dictates a take-off gross weight of approximately 75,000 lbs. With a 6000 lb. payload, this gross weight will give a range of approximately 1000 statute miles. The detail program required for the development of such a missile is outlined below. Also included in this detail program are engineering design studies leading to the use in the future of more advantageous trajectories and propulsion systems.

1. Engineering design and construction of five (5) 6000 lb. warhead, 1000 mile missiles.
2. Test of component parts. This would include:
 - a. Structural testing of one or more alternate designs of a complete missile airframe under all anticipated loading conditions.
 - b. Operational tests of power plant and control components.
 - c. Test of the complete stabilization system on a simulator.
 - d. Subsonic and supersonic wind tunnel tests.
3. Guidance: Continuation of the work already accomplished by CVAC on projects MX-774 and MX-770. This would include the testing of guidance components in (1) actual flight on conventional aircraft, (2) the present MX-774 test vehicles, and, (3) the missiles to be built under this program.
4. Design and construction of a facility to static fire the missile. This would be an expansion of the static firing facility now being used for MX-774 Test Vehicles.
5. Static firing and flight testing of the missiles.

DEVELOPMENT PROGRAM (Cont'd)

6. Warhead design studies including thermodynamic studies of re-entry, investigation and test of heat resisting materials, stabilization and ejection of warhead.
7. Evaluation studies of rocket type missiles. This would include:
 - a. Design studies of missiles of various payloads and ranges as dictated by tactical requirements.
 - b. Studies of missile configuration based on improved motors and/or fuels as current programs or trends in the propulsion field may indicate.
 - c. Studies of different types of trajectories such as maximum L/D glide path.
 - d. Investigation of improved methods of guidance.
 - e. Study of possible refinements in component design, e.g. improved gyros and accelerometers, tank pressurization by gas generation, new structural methods and materials making for lighter weight. The study of semi-rigid fuel bags for instance would be an example.
 - f. Investigation of guidance methods for trajectories other than ballistic.

Tentative Estimated Labor Requirements, Schedule and Cumulative Cost curve shown on the following pages are based on the first two years of this program. The data for these curves have been predicated on the bases of this program being pursued in conjunction with the manufacture and testing of MX-774 Flight Test Vehicles, on which quotations have previously been submitted.

ITEM	MEN PER MO.	MONTHS			
		J	F	M	
1 DESIGN & CONSTRUCTION OF AIRFRAMES — INCL. W.T. & COMPONENT TESTING.	ENG. SHOP	20	35	40 20	
2 GENERAL DESIGN STUDIES & REPORTS.	ENG. SHOP	5 2	7 4	9 5	
3 GUIDANCE & STABILIZATION.	ENG. SHOP	29	35	45	
4 MODIFICATION OF TEST FACILITY (PT. LOMA) & CONSTRUCTION OF HANDLING EQUIPMENT.	ENG. SHOP		2	4	
5 STATIC TESTS AT POINT LOMA.	ENG. SHOP				
6 FLIGHT TESTS & REPORTS (BASED ON TESTING AT WHITE SANDS FACILITY)	ENG. SHOP				
EST. TOTAL LABOR		ENG.	54	79	98
		SHOP	2	4	25

MAN-MONTHS OF DIRECT LABOR	180	ENGINEERING
	160	
	140	
	120	
	100	
	80	
	60	
	40	
	20	
	0	

MADE IN U.S.A.
 Manufactured by the
 KENNEL & EBER CO., N. Y. NO. 322-141

1949										1950										
A	M	J	J	A	S	O	N	D	J	F	M	A	M	J	J	A	S	O	N	D
40	40	36	28	22	17	11	8	8	4	4	4	4	4	4	4	4	4	4	4	4
45	80	100	100	120	125	120	115	104	95	75	50	45	45	45	45	45	45	45	45	45
10	10	12	14	15	18	20	20	20	20	20	20	20	20	20	20	20	20	20	20	20
5	5	6	7	8	9	10	10	10	10	10	10	10	10	10	10	10	10	10	10	10
55	60	65	75	80	80	80	75	75	70	65	55	35	35	35	35	35	35	35	35	35
			5	10	10	20	20	20	20	20	20	20	20	20	20	20	20	20	20	20
2	1	1	1	1	1	2	4	4	1	1	1	1	1	1	1	1	1	1	1	1
						10	13	20	5	2	2	2	2	2	2	2	2	2	2	2
						2	6	10	22	22	22	22	22	22	22	22	22	22	22	22
							2	4	15	15	15	10	10	10	10	10	10	10	10	10
									5	10	20	40	40	40	40	40	40	40	40	40
										5	10	20	20	20	20	20	20	20	20	20
107	111	114	118	118	116	115	113	117	122	122	122	122	122	122	122	122	122	122	122	122
50	85	106	112	138	144	160	160	158	145	127	107	107	107	107	107	107	107	107	107	107

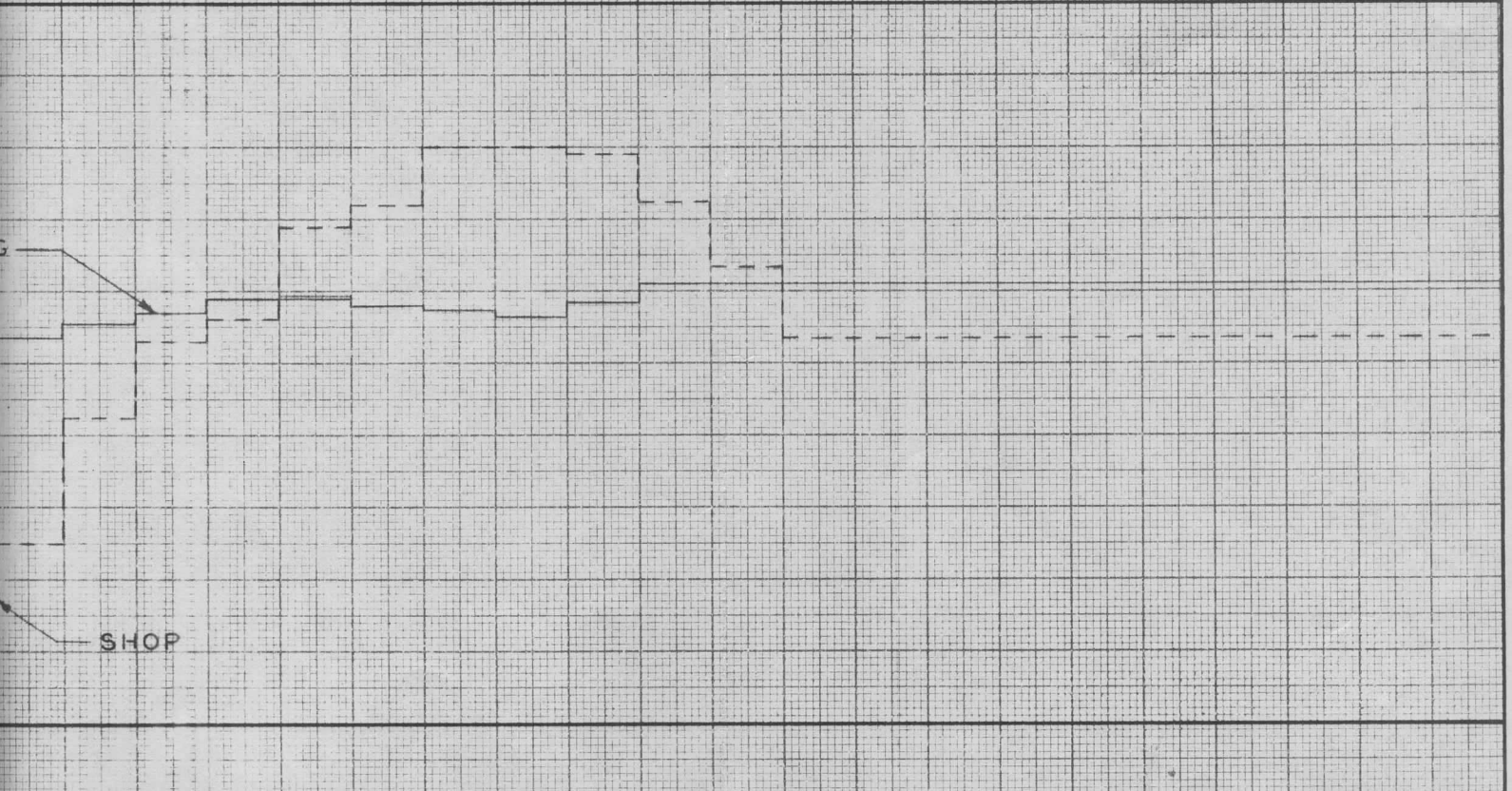

TENTATIVE SCHEDULE -

MOS. AFTER GO-AHEAD	1	2	3	4	5	6	7	8	9	
ENGINEERING										
DESIGN & DEVELOPMENT						█			█	
GEN. DESIGN STUDIES										
GUIDANCE & STABILIZATION										
EXPERIMENTAL SHOP										
TOOLING			█							
MANUFACTURE					█					
FACILITY										
DESIGN			█							
CONSTRUCT. & INSTRUMENT.				█						
POWER PLANT - (R.M.I.)										
			← PLACE CONTRACT WITH R.M.I.				█			
STATIC TESTS										
* MX-774 SOUNDING VEHICLES										
MX-774 1000 MI. MISSILES										
FLIGHT TESTS										
* MX-774 SOUNDING VEHICLES										
MX-774 1000 MI. MISSILES										
* COSTS FOR THESE VEHICLES NOT INCL. IN THIS PROGRAM.										
J F M A M J J A S										
1949										

MADE IN U.S.A.
 Manufactured by Jones & Lamson
 Kennebunk, Maine
 Kennebec & Essey Co., N. Y. No. 328-117

10 11 12 13 14 15 16 17 18 19 20 21 22 23 24 25 26 27 28

L I A I S O N

1 2 3 4 5

I N S T R I M A I N T E N A N C E

SPARE

2 3 4 5 6

2 3 4 5 6 7 8 9 10
1 2 3 4 5

1 2 3 4 5 6 7 8 9 10
1 2 3 4 5

O N D J F M A M J J A S O N D J F M A
1950 1951

SECRET

41-252.001 Y. H. .00 22222 & JETTUEN
272521 2221 .00 222222 2221 .00 2222222222
.A.S.U. H. 2222

MX-774 PROGRAM

ACCUMULATIVE ESTIMATED COST FORECAST

Report No. ZP-48-35003
Page 8

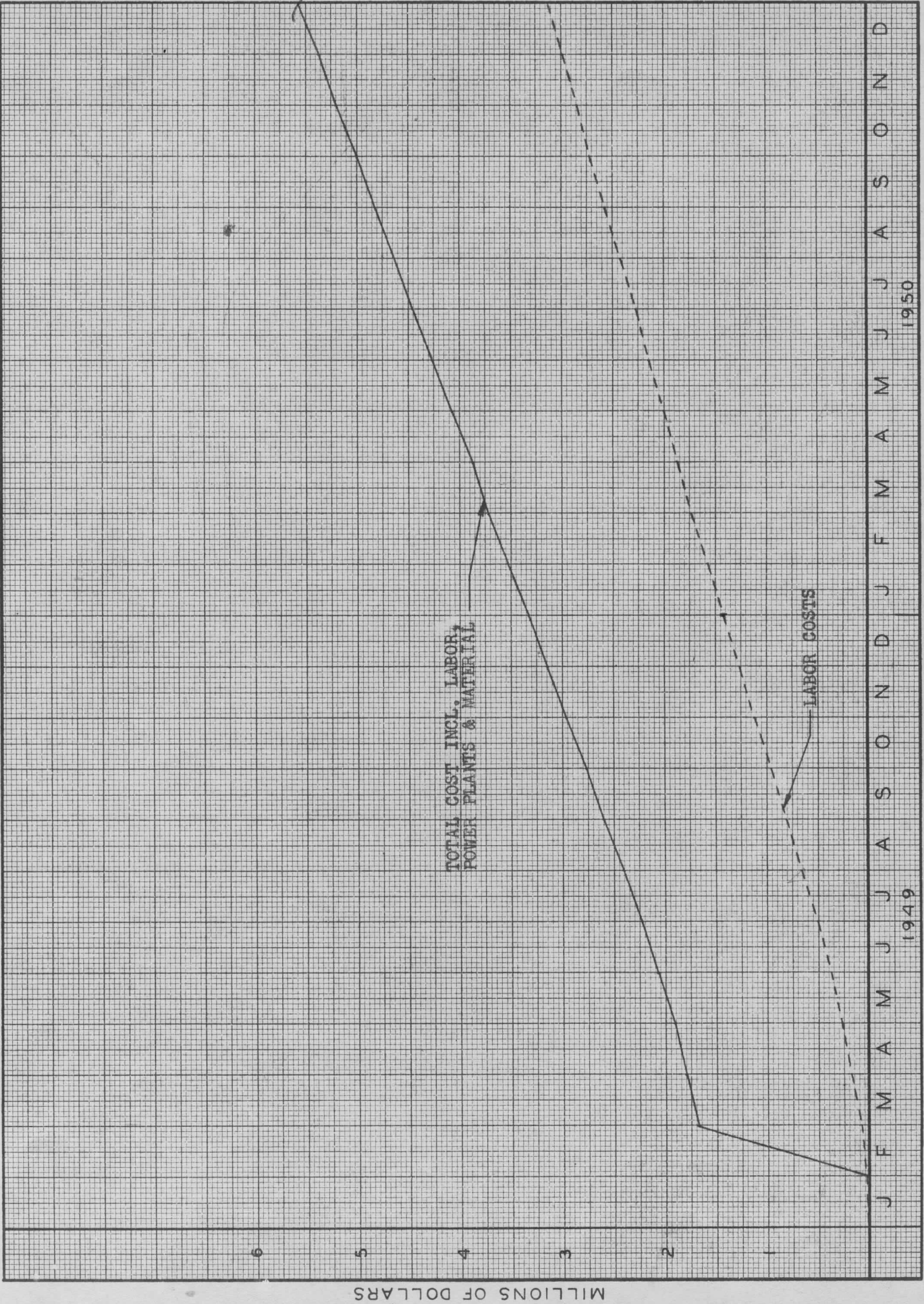

ANALYSIS
PREPARED BY
CHECKED BY
REVISED BY

CONSOLIDATED VULTEE AIRCRAFT CORPORATION

SAN DIEGO DIVISION

SECRET

PAGE 9

REPORT NO ZP-48-3500

MODEL

DATE NOV. 23, 194

PROPOSED MISSILE

WARHEAD - 6000 LB

RANGE - 1000 ST. MILES

DESCRIPTION

(6000 LB. WARHEAD, 1000 MILE)

GENERAL

The following is a description of the proposed missile (see following sketches).

Overall length	-	63 ft.
Body diameter	-	6.3 ft.
Gross weight	-	73,484 lb. distributed as follows:
Warhead (payload)	-	6000 lb.
Range (approx.)	-	1000 st. miles
Fabricated weight	-	2894 lb.
Fuel weight	-	62,140 lb.
Total thrust at take-off	-	108,000 lb.

Note: An alternate payload of 500 lb., giving greater range for test purposes, is also considered at the end of this description.

Some of the more salient features embodied in this design are:

Only existing power plants are used.

Stabilization is achieved by swiveling of the rocket motors. This method of stabilization was proven to be very effective in the MX-774 Test Vehicle Flights.

The warhead is jettisonable. This feature is primarily responsible for the high mass ratio that can be attained in this missile. Unlike the case of the V-2 rocket, the airframe structure need not be designed for the very high loads occurring at re-entry into the atmosphere. The resulting weight saving is obvious.

Incidental to the mass ratio gain, the light weight of the airframe when compared to the warhead weight results in the advantage of bringing the center of gravity forward. This, of course, is beneficial from the stability standpoint and permits a reduction in fin size resulting in a further reduction of weight and drag.

The center of gravity of the final stage of this missile is so far forward that this configuration will be inherently stable without fins.

DESCRIPTION (Cont'd)

(6000 LB. WARHEAD, 1000 MILE)

The method of "staging" of the proposed missile is novel inasmuch as no "booster stage" fuel tanks are dropped. To go from the booster stage to the final stage, only power plants and pressurizing equipment, fins and aft body fairing are dropped. This feature greatly simplifies the problem of separation between stages.

AIRFRAME

Aft body sections are fabricated of riveted aluminum alloy sheets on ring type stiffener bulkheads.

Forward body section which consists of the two propellant tanks is of welded aluminum alloy construction sufficiently reinforced to carry bending loads and support the warhead.

The tank section may be reinforced for handling loads by removable external ring bulkheads.

The aft section supports the fins and houses all stabilization, guidance, power plants and pressurizing equipment.

All equipment and engines belonging to the final stage are supported directly from the tank section on a tubular mount.

All booster stage engines and equipment are supported from the aft body. At separation, the entire aft body including fins and booster stage equipment, is dropped off.

Fins of aluminum alloy riveted construction are provided for aerodynamic stability during the first part of the flight. Slow trim tabs are provided for correcting manufacturing misalignments.

POWER PLANT

The booster stage power plant consists of four 20,000 lb. thrust swiveling units.

The final stage power plant consists of one 20,000 lb. thrust stationary unit surrounded by four 2000 lb. thrust swiveling units. By shutting off the stationary unit, this arrangement permits reduction of the thrust before fuel shut-off from 28,000 lbs. to 8,000 lbs. while still maintaining control.

DESCRIPTION (Cont'd)

(6000 LB. WARHEAD, 1000 MILE)

POWER PLANT (Cont'd)

The propellants are alcohol and liquid oxygen.

Propellant pressures are furnished by hydrogen peroxide (H_2O_2) steam-driven turbine pumps. Pressure for the liquid oxygen and H_2O_2 tanks is provided by passing liquid oxygen through a heat exchanger on the turbo exhaust. Helium, contained in a spherical tank, is used for pressurizing the alcohol tank for the first part of the powered flight. This tank drops off with the booster stage equipment. The helium gas already present in the fuel tank at the time of separation is sufficient to maintain adequate pressure for the remainder of the flight. All engines are operated at take-off thus eliminating the need for starting during flight.

STABILIZATION AND GUIDANCE

Due to the favorable location of the missile c.g., it is no longer necessary to locate stabilization and guidance equipment in the nose. Locating this equipment in the aft body presents the following advantages:

Shorter wiring and coaxial cables eliminate both weight and undue power loss in UHF equipment.

Accessibility is greatly improved for pre-fire check-out.

The stabilization system proposed is substantially the same as that used in the MX-774 test vehicle. Attitude and angular velocity in roll, pitch and yaw are sensed by free and rate gyros. Electrical error signals from these gyros are mixed with follow-up and integral signals in the proper proportions, amplified and fed to the solenoids of the control valves. These valves regulate the flow of hydraulic fluid to the actuating cylinders which swivel the rocket motors.

As in the MX-774, alcohol pressurized by the fuel pump will be used for hydraulic fluid thus eliminating the need of a separate source of hydraulic pressure.

The guidance system is described elsewhere in this report. All high voltage equipment subject to arcing at low pressures will be enclosed in pressurized containers.

DESCRIPTION (Cont'd)

(6000 LB. WARHEAD, 1000 MILE)

WARHEAD

The warhead which forms the nose of the missile is fitted with a conical shaped stabilizing tail to keep it from tumbling on re-entry.

As may be seen in the weight statement of Appendix A, the weight of this stabilizing skirt was not included in the 6000 lb. warhead weight when used in performance calculation.

The warhead is secured to the tank section during flight and may be jettisoned at any time between fuel shut-off and re-entry into the atmosphere.

By the use of a suitable jettisoning device, it may be possible to make small corrections to the warhead velocity at fuel shut-off, thus improving the accuracy at the target.

The warhead shape and dimensions shown by the following sketches may be changed to suit military requirements.

ALTERNATE PAYLOAD OF 500 LB.

By replacing the 6000 lb. warhead with a reduced payload this missile can be used as a long range research vehicle to explore many problems involved in extreme range missiles. Problems such as guidance, warhead re-entry, upper atmospheric research, and investigations of such trajectories as the RAND proposed "glide" and "skip" trajectories can be carried on with minimum alteration of the basic missile.

The range obtainable with a 500 lb. payload is approximately 2644 miles.

In a vertical trajectory the maximum altitude is approximately 798 miles with a 500 lb. payload.

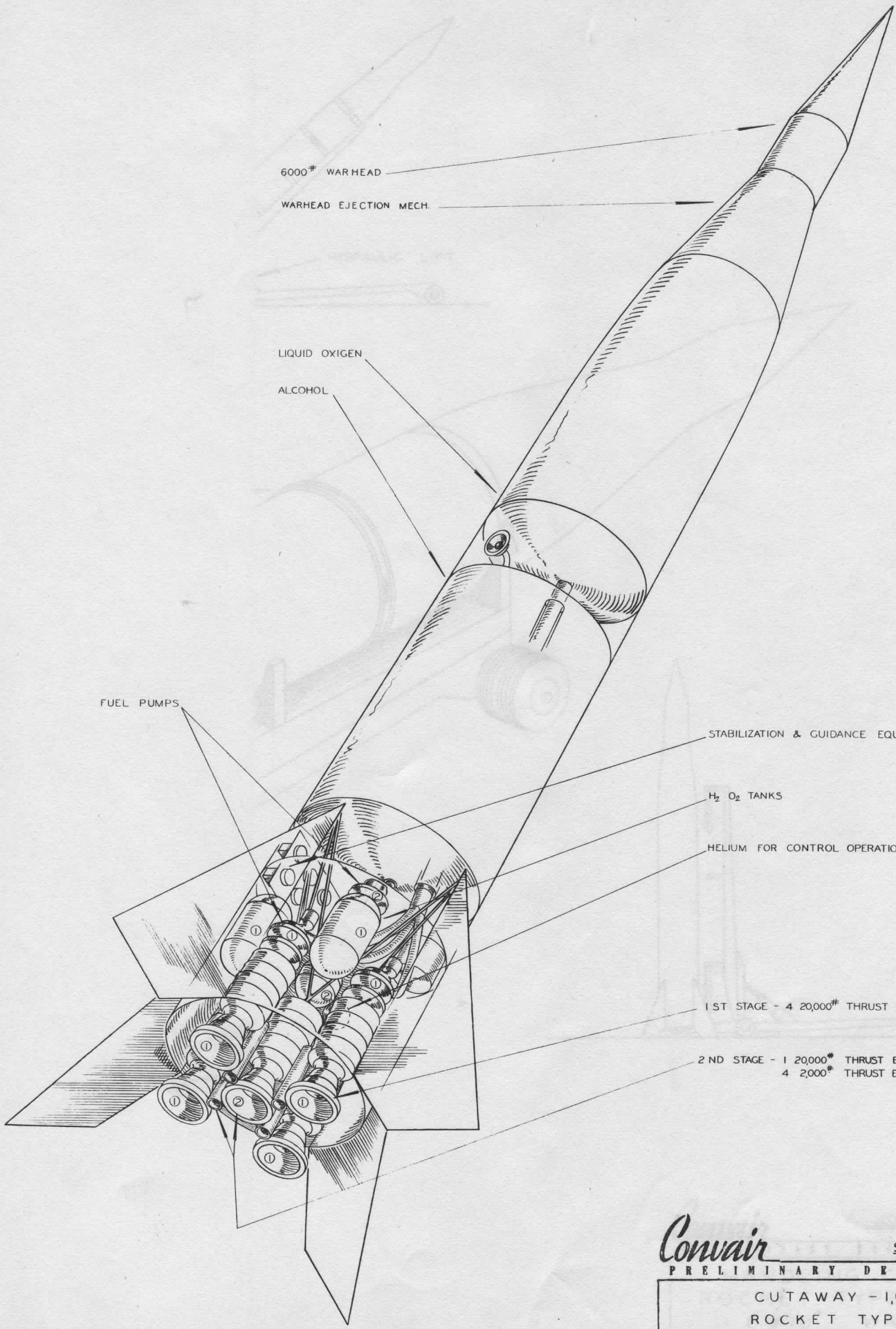

6000# WARHEAD
 WARHEAD EJECTION MECH.

LIQUID OXYGEN
 ALCOHOL

FUEL PUMPS

STABILIZATION & GUIDANCE EQUIPMENT

H₂ O₂ TANKS

HELIUM FOR CONTROL OPERATION

1 ST STAGE - 4 20,000# THRUST ENGINES JETTISONED

2 ND STAGE - 1 20,000# THRUST ENGINE
 4 2,000# THRUST ENGINES

Convair

SECRET

PRELIMINARY DESIGN DRAWING

CUTAWAY - 1,000 MILE
 ROCKET TYPE MISSILE
 6,000 * WARHEAD

BY CHECKED APPROVED DATE
 CONSOLIDATED VULTEE AIRCRAFT CORPORATION SD - 48-3500

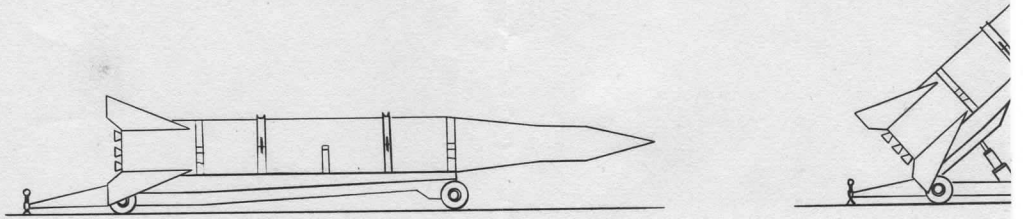

REMOVABLE EXTERNAL BULKHEADS FOR
STIFFENING TANKS WHILE HANDLING

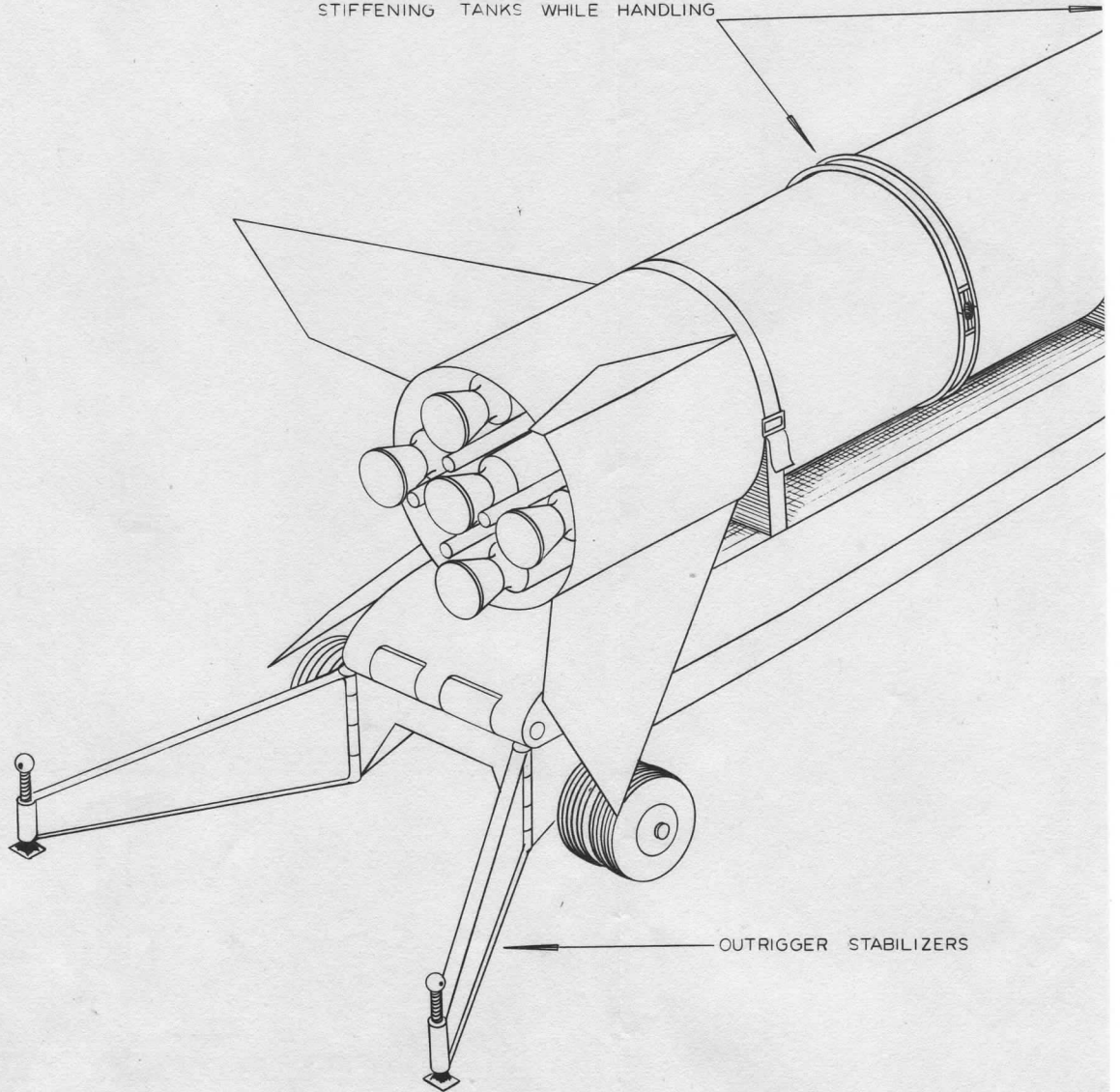

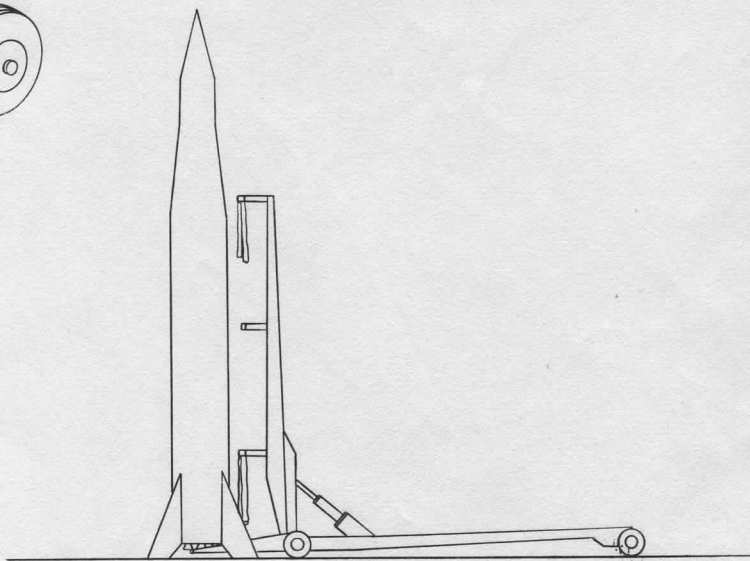
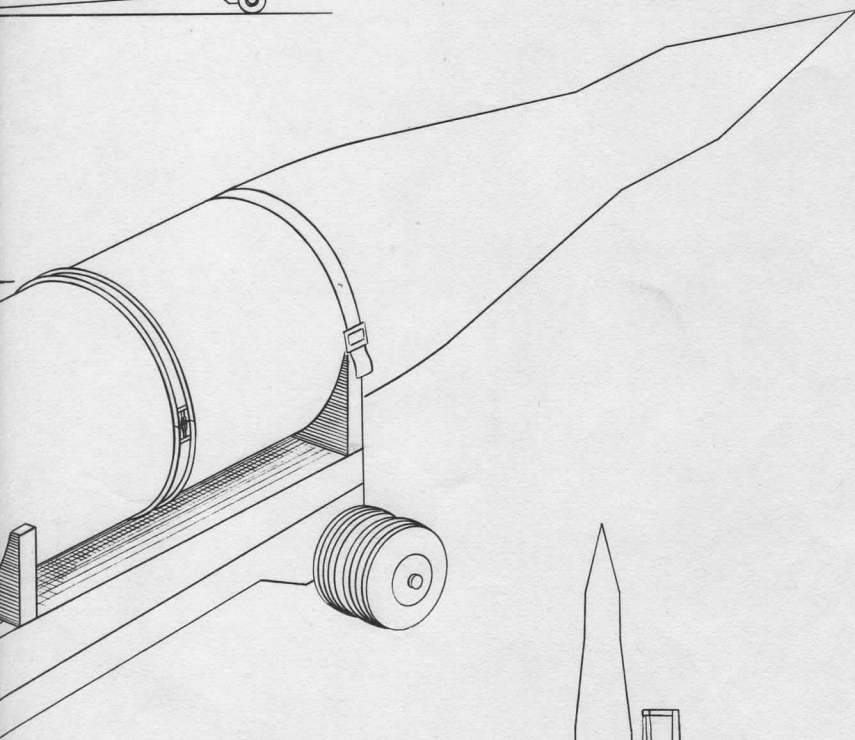
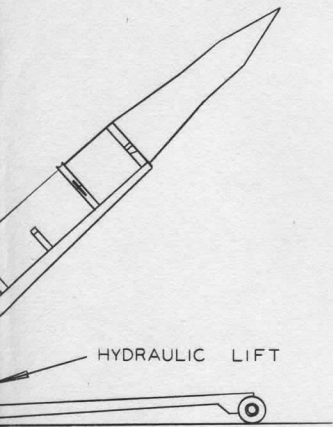

Convair

SECRET

PRELIMINARY DESIGN DRAWING

HANDLING CARRIAGE
ROCKET TYPE MISSILE
6,000* WARHEAD

BY DORLAND	CHECKED <i>an</i>	APPROVED <i>com</i>	SCALE —	DATE 11-23-46
CONSOLIDATED VULTEE AIRCRAFT CORPORATION			SD 48 35004	
SAN DIEGO CALIFORNIA				

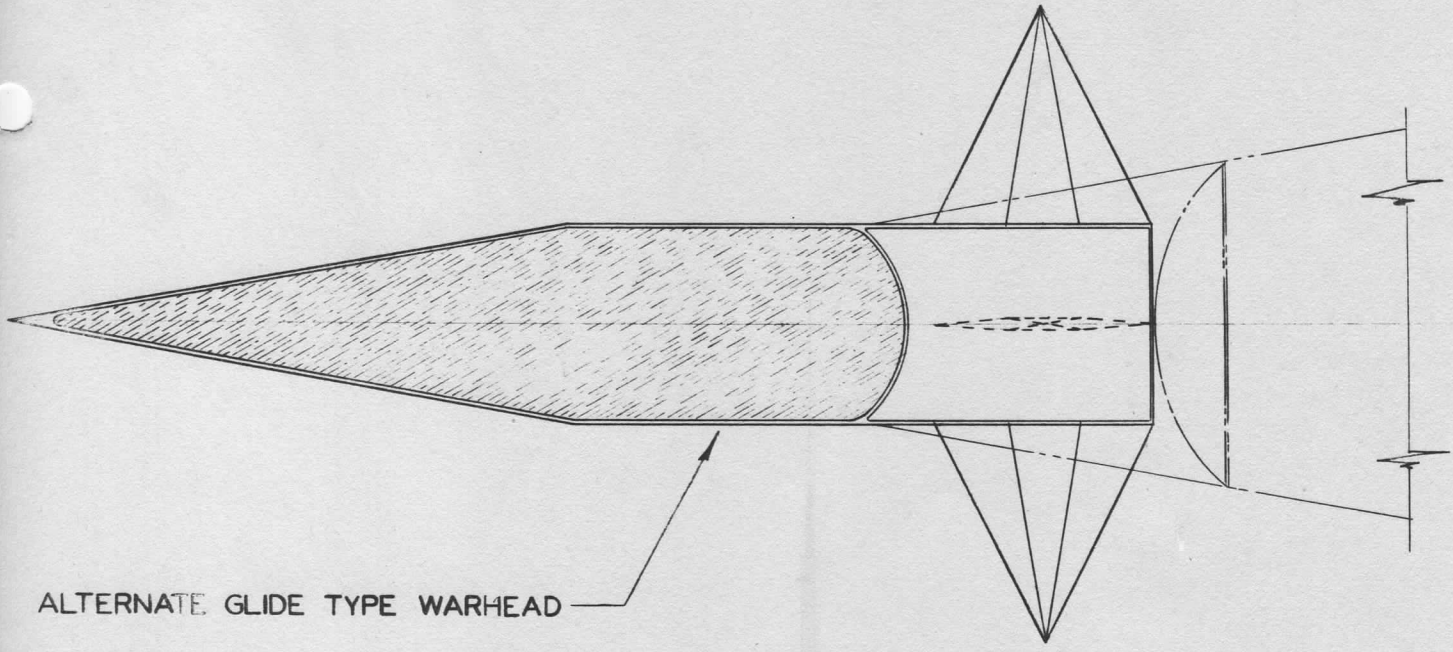

ALTERNATE GLIDE TYPE WARHEAD

6,000 LB. WARHEAD

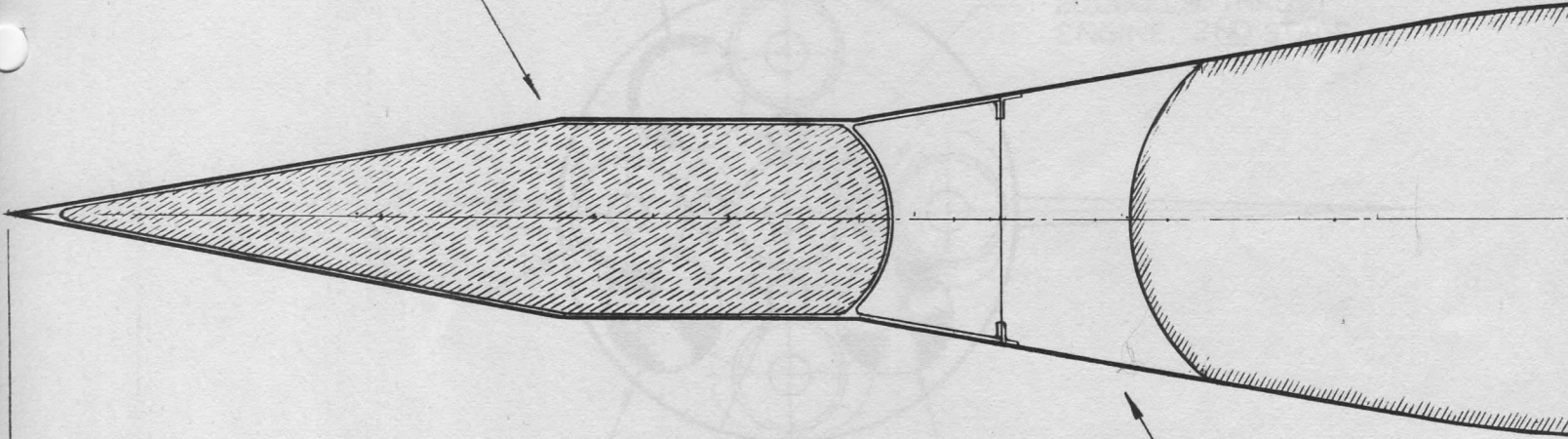

WARHEAD EJECT

4-1ST STAGE 20,000 LB
 THRUST 2.5 G
 (ATTACHED)

HELIX FOR A TYPE
 PRESSUREING (ATTACHED)

SECRET

1000 MILE
 ROCKET TYPE MISSILE
 6000 LB WARHEAD

EXPERIMENTAL MISSILE DEVELOPMENT

LIQUID OXYGEN TANK

ALCOHOL TANK

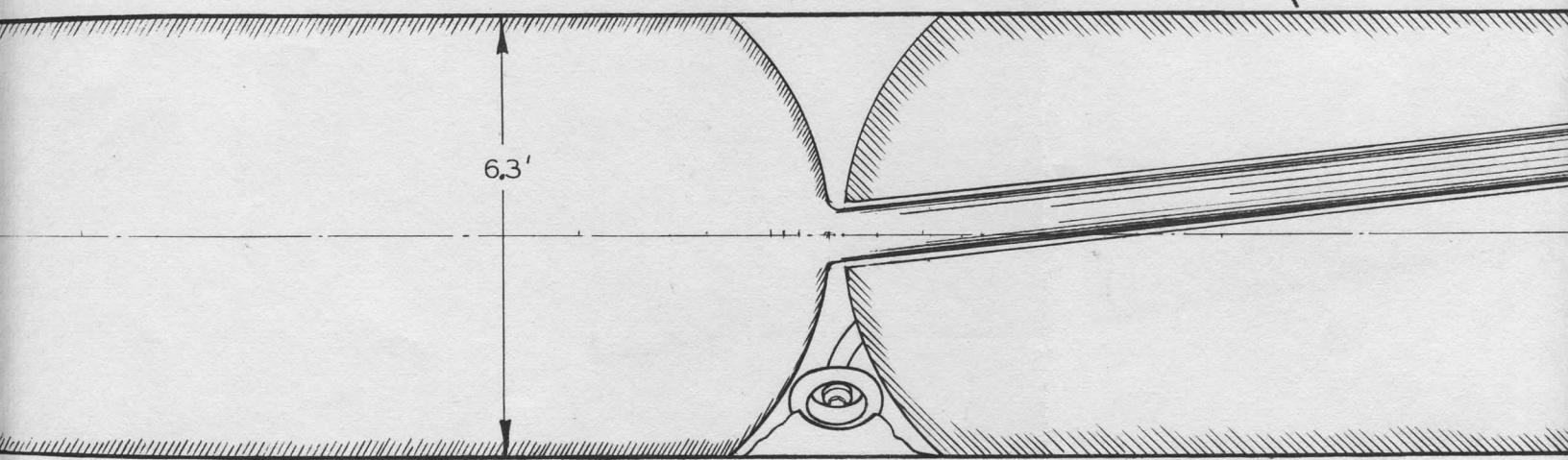

6.3'

MECHANISM

ALCOHOL FILLER FITTING

BREAKA
FINS &
1ST S

63'-0"

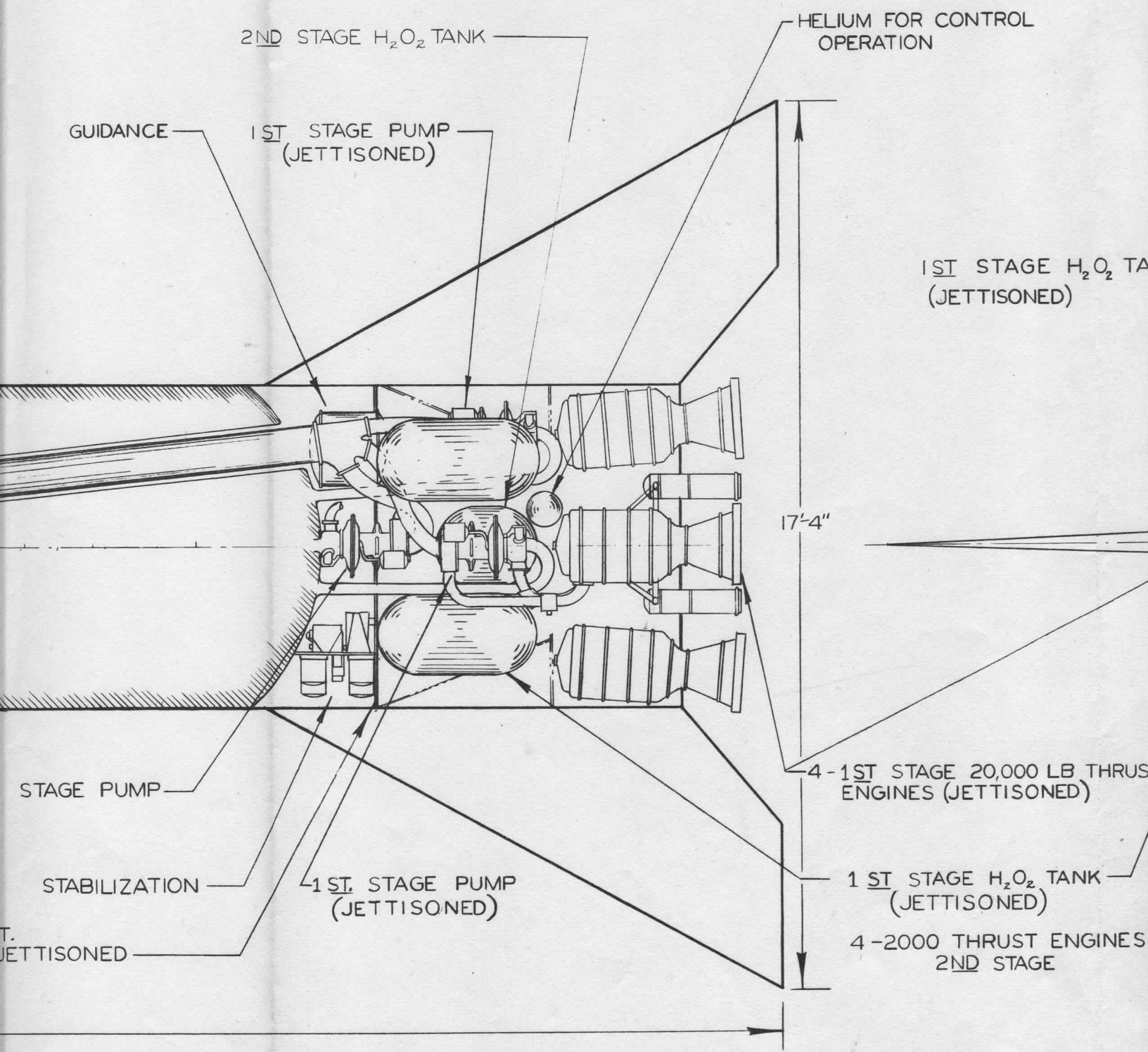

T.
JETTISONED

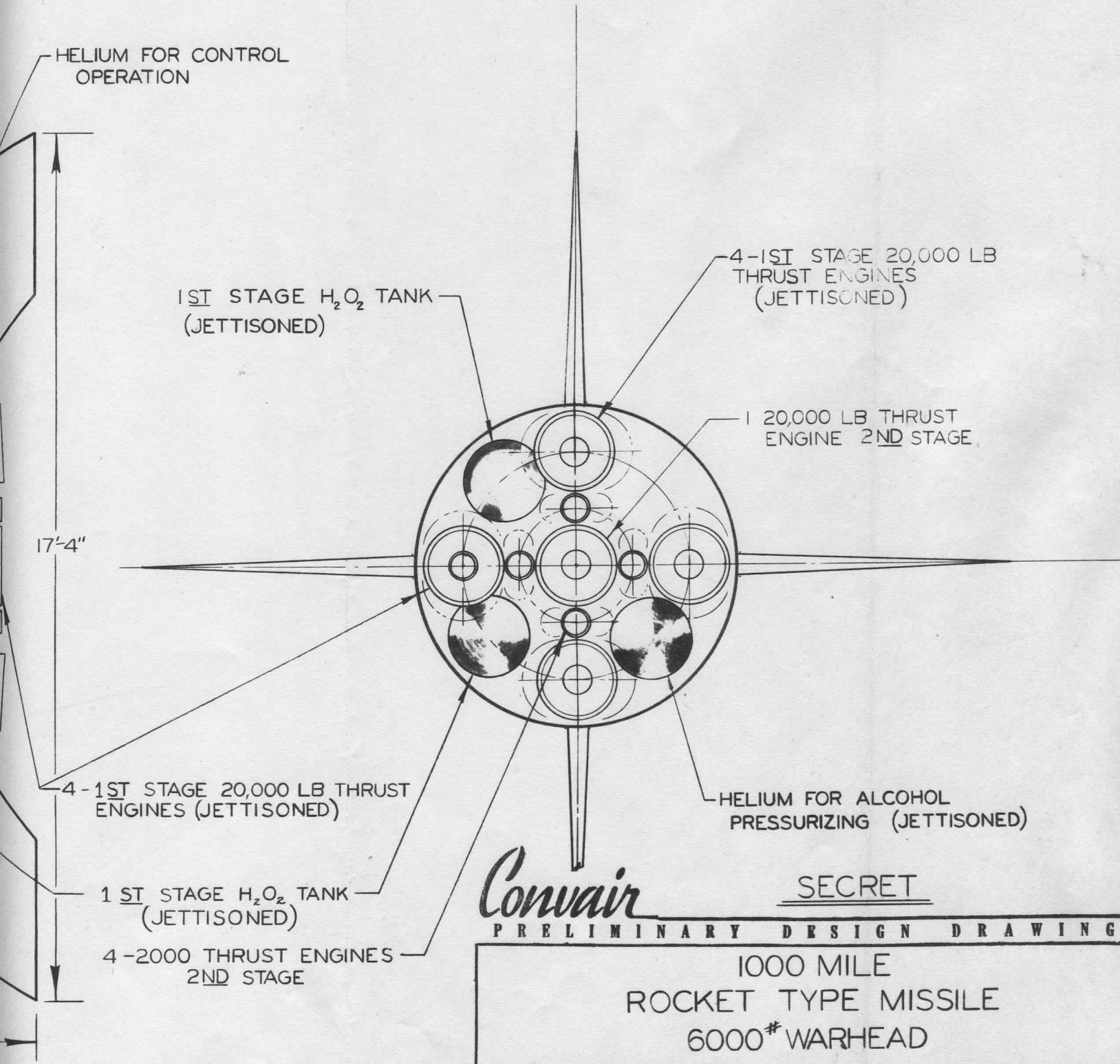

Convair

SECRET

PRELIMINARY DESIGN DRAWING

1000 MILE
ROCKET TYPE MISSILE
6000# WARHEAD

BY <i>J. E. Kel</i>	CHECKED <i>csa</i>	APPROVED <i>MB</i>	SCALE 1/16	DATE 1-23
CONSOLIDATED VULTEE AIRCRAFT CORPORATION SAN DIEGO CALIFORNIA			SD-48-35001	

ANALYSIS
PREPARED BY
CHECKED BY
REVISED BY

CONSOLIDATED VULTEE AIRCRAFT CORPORATION

SAN DIEGO DIVISION

SECRET

PAGE 18
REPORT NO ZP-48-35003
MODEL
DATE NOV. 23, 194

GUIDANCE AND CONTROL

GUIDANCE AND CONTROL

GENERAL DISCUSSION

(a.) Trajectories

The flight of an over-the-atmosphere rocket missile may be divided into three phases: 1) a powered phase, 2) a free-flight phase and 3) a re-entry phase. A large part of the powered phase and all of the free-flight phase are conducted above the effective height of the earth's atmosphere.

The powered phase lasts less than five minutes, during which time the missile travels perhaps 100 miles toward the target and reaches an altitude of approximately 100 miles. After rising vertically a few seconds the missile is caused to follow a curved path to enter the free-flight phase in the proper direction and angle of climb. For purposes of discussing guidance and control the path during powered flight may be considered similar to that shown in Fig. 1.

Upon shutting off of fuel and termination of powered flight, the missile enters the free-flight phase. From the time of fuel shut-off until it returns to the atmosphere in the vicinity of the target, the missile is in free flight constrained only by the earth's gravitational field. Its path is a Kepler ellipse with one of the foci at the earth's center, and is subject to the same laws of celestial mechanics as a satellite except that its elliptical orbit intersects the earth's surface at two points, one near the launching point and the other at the target. (A complete treatment of this subject is contained in Ref. 1, App. B, Calculation of Long Range Trajectories, CVAC Report No. ZN-6002-010.)

The third phase of flight commences when the missile trajectory re-enters the effective atmosphere and is acted upon by aerodynamic forces. The missile is slowed down thereby and its path deviates a predictable amount from the free-flight Kepler ellipse.

(b.) The Aiming Problem

The weighting of the various factors entering into the determination of the aiming direction and range of a long range projectile-type missile are somewhat unconventional. For example, in ordinary artillery firing the rotation of the earth, the variation of gravity with elevation, and the earth's curvature are of secondary importance. Where the range is greatly increased over conventional artillery problems these factors, however, are the principal ones which govern the behavior of very long range projectile-type missiles such as the MX-774.

GUIDANCE AND CONTROL

GENERAL DISCUSSION

(a.) Trajectories

The flight of an over-the-atmosphere rocket missile may be divided into three phases: 1) a powered phase, 2) a free-flight phase and 3) a re-entry phase. A large part of the powered phase and all of the free-flight phase are conducted above the effective height of the earth's atmosphere.

The powered phase lasts less than five minutes, during which time the missile travels perhaps 100 miles toward the target and reaches an altitude of approximately 100 miles. After rising vertically a few seconds the missile is caused to follow a curved path to enter the free-flight phase in the proper direction and angle of climb. For purposes of discussing guidance and control the path during powered flight may be considered similar to that shown in Fig. 1.

Upon shutting off of fuel and termination of powered flight, the missile enters the free-flight phase. From the time of fuel shut-off until it returns to the atmosphere in the vicinity of the target, the missile is in free flight constrained only by the earth's gravitational field. Its path is a Kepler ellipse with one of the foci at the earth's center, and is subject to the same laws of celestial mechanics as a satellite except that its elliptical orbit intersects the earth's surface at two points, one near the launching point and the other at the target. (A complete treatment of this subject is contained in Ref. 1, App. B, Calculation of Long Range Trajectories, CVAC Report No. ZN-6002-010.)

The third phase of flight commences when the missile trajectory re-enters the effective atmosphere and is acted upon by aerodynamic forces. The missile is slowed down thereby and its path deviates a predictable amount from the free-flight Kepler ellipse.

(b.) The Aiming Problem

The weighting of the various factors entering into the determination of the aiming direction and range of a long range projectile-type missile are somewhat unconventional. For example, in ordinary artillery firing the rotation of the earth, the variation of gravity with elevation, and the earth's curvature are of secondary importance. Where the range is greatly increased over conventional artillery problems these factors, however, are the principal ones which govern the behavior of very long range projectile-type missiles such as the MX-774.

GUIDANCE AND CONTROL (Cont'd.)

(b.) The Aiming Problem (Cont'd.)

The missile follows an elliptical path which lies in a plane passing through the center of the earth, but not rotating with the earth. While the missile is in flight above the atmosphere the earth turns under it.

Because the earth is rotating, it is necessary to aim the missile - not at the point on the earth where the target is located - but at the particular point in space where the target will be when the missile arrives. Other factors such as local variations in the earth's gravitational field have smaller but important effects on the aiming point. (These problems are discussed in detail in Ref. 1, App. B.)

(c.) General Approach to Guidance

A study of celestial mechanics shows that, for a given elliptical free-flight missile path, the magnitude and direction of the velocity vector at any point along the path is a determinant. The problem of guidance, then, resolves itself primarily into the precise adjustment of magnitude and direction of the velocity vector of the missile in relationship to its predetermined position at the instant of fuel shutoff. From the standpoint of the actual control technique, the problem is that of precisely directing the missile's velocity vector and shutting off rocket fuel in such a manner that its vector reaches a value corresponding to a point on the desired ellipse.

In the proposed system, the missile will be controlled by primary and secondary guidance systems, the functions of which are supplementary. A block diagram of the proposed system is shown in Figure 2.

The secondary system is similar in principle to that used by the Germans in the A-4 (V-2) missile in that it consists of an automatic pilot which contains a preset flight program. The automatic pilot consists of the missile stabilization system to which is added integrating accelerometer control of fuel shut-off. This equipment is capable in itself of controlling the missile during any inoperative periods of the primary guidance equipment; however, the accuracy of control provided is insufficient to meet the exacting specifications prescribed for this missile.

The primary guidance system employs radio equipment located both within the missile and at a remote control station situated on the ground. Since the flight of the missile will at all times be under control of the automatic pilot, the radio guidance equipment will steer the missile by injecting signals into the automatic pilot equipment. The automatic pilot

GUIDANCE AND CONTROL (Cont'd.)

(c.) General Approach to Guidance (Cont'd.)

portion of the guidance system is capable of correcting any rapid deviations of the missile from the prescribed path, whereas minute errors which might persist for a longer period of time resulting in cumulative errors within the automatic pilot equipment will be readily detected and corrected by the primary guidance equipment.

The primary guidance system employs tracking, computer and command equipment. In operation, the tracking system observes the missile's behavior precisely. The computer is used to compare the observed behavior of the missile with its predicted behavior or flight program, and to determine the nature and extent of any corrections found necessary to direct the missile towards the target. The resulting information is conveyed by means of radio command to the missile where it is injected as steering signals into the stabilization system. If for any reason the radio command signals from the remote control station should fail, the missile will continue to the target region with whatever accuracy is inherent in the automatic pilot, improved by whatever command signals may have been received from the remote control station prior to failure.

Figure 1 is a sketch of the missile's flight program during the powered portion of its flight. As mentioned earlier, the missile is at all times under control of the automatic pilot which, during the period of the missile's initial launching, provides its only control. When the missile rises above the radio horizon at the remote control station, the tracking equipment begins to function by "following" the missile. This surveillance phase continues long enough for the computer to achieve smooth operation. Thereafter the remote control station transmits any commands found necessary to maintain the missile on a precise course. A short time before the missile reaches terminal velocity under full acceleration, the secondary guidance system reduces the thrust. Final precise commands are then received from the ground station, after which the missile proceeds under the internal control of the automatic pilot only. When the necessary additional increment of velocity has been acquired, the last stage of thrust is completely cut off by the internal accelerometer. The missile finishes its flight as a free projectile.

(d.) Precision Tracking Requirements

The major problem in guiding ballistic-type long range missiles is tracking them with sufficient accuracy. The requirement in determining the magnitude of the missile's velocity vector so as to shut off rocket fuel at the instant the desired velocity is attained is notably stringent. To meet the accuracy specification of striking within a 2,500-foot radius of a target at 1,000 miles range, six flight parameters must be held

GUIDANCE AND CONTROL (Cont'd.)

(d.) Precision Tracking Requirements (Cont'd.)

within the limits tabulated below. Guidance errors at the fuel shutoff point are discussed in terms of missile tracking requirements in an analytical report, Selection of Guidance System for MX-774 Missile, CVAC Report No. DEVF-4052. (Ref. 2, App. B) The error equations for all factors of the elliptical free-flight path are derived and discussed in detail in Ref. 1, App. B. These limits are taken for simplicity as the error in any one factor which, if the other five were kept zero, would result in a target error of 2,500 feet at 1,000 miles range.

MISSILE GUIDANCE ERRORS WHICH INDIVIDUALLY WOULD CAUSE A 2,500-FOOT ERROR AT THE TARGET AT 1,000 MILES RANGE:

MISSILE VELOCITY VECTOR			FUEL SHUTOFF POSITION		
Magnitude	Azimuth Angle	Elevation Angle	Forward or Backward	Sideways	Upward
± 3 ft/sec	(0.03 degrees)	(0.02 degrees)	0.5 mile	0.35 Miles	0.4 Miles

The above tabulation of flight parameter limits emphasizes the accuracy requirements in controlling missile velocity. Since the missile velocity is approximately 10,600 feet per second for 1,000 miles range, the measurement of velocity must be made with an accuracy better than one part in 3,200 (0.03%). In order to achieve this accuracy the missile must be tracked continuously during the powered phase with precision. Consequently, this guidance proposal emphasizes primarily the Radio Phase-Comparison Precision Tracking System developed by CVAC under the original provisions of the MX-774 missile contract and presently being applied by CVAC in general principle to development of the MX-770 missile guidance system. (See App. B for further description.)

(e.) Pin Point Guidance

Regardless of the inherent precision of any ballistic system, the hitting accuracy can be no better than the knowledge of the target location. Particularly in the case at long range, map errors and lack of agreement between coordinate systems may introduce considerable discrepancy between the assumed target position and actual. The lack of agreement between various detailed map systems throughout the world imposes an additional burden for the guidance of long range missiles. This difficulty has also often been encountered in long range artillery. Usually artillery fire control utilizes "spotting" to increase the accuracy and achieve a final vernier adjustment for pin point hits. This same principle in vernier guidance or fire control may be applied to ballistic missiles. For example, an observation plane flying at an altitude slightly in excess of 50,000

GUIDANCE AND CONTROL (Cont'd.)

(e.) Pin Point Guidance (Cont'd.)

feet could perform a spotting function for missiles being dropped into a target at a distance of about 250 miles from the airplane. In other words, for a 1000 mile missile an observation plane could be used at a point approximately 750 miles from the launching site in the direction of the target. The use of such an observation plane for spotting has many obvious tactical disadvantages, such as vulnerability to enemy action and the difficulty of performing accurate spotting in all types of weather and the relay of information back to the launching site.

The ballistic missile offers in itself a very interesting possibility for performing its own spotting function. A missile of considerably lighter weight and consequently a less expensive unit would be used for the spotter missile. It would fly the trajectory and use the same guidance equipment as the tactical warhead equipped units. At the point of re-entry into the atmosphere, the radar repeater equipped with a ribbon parachute would be jettisoned. The war-head would be equipped with a small packet of "shaft" or "curtain" which would be immediately detected by the radar upon detonation of the war-head. The location of the shaft and extent of explosion of the war-head would be indicated by the partially suspended radar in relationship to other radar images or fixes in the target area. This information would be repeated back to the launching point so that vernier adjustments on the control guidance could be accomplished before firing the main salvo.

At ranges greater than 1000 miles, it would probably be necessary to utilize an intermediate relay in order to convey the radar repeater spotter information back to the launching site. This would impose considerable technical difficulty, but no new basic principles are involved.

For ranges approximating 1000 miles over land, seismographic methods of spotting initial trial rockets could be used. In event the target was adjacent to a large body of water, which comprised the bulk of the intervening path, seismographic methods could be used over considerably greater ranges.

The use of some form of spotting or observing trial shots in order to assist in the vernier with adjustment of the guidance system before final salvo, would greatly enhance the accuracy. It appears reasonable from a detailed consideration of the missile guidance system and trajectory studies, that the flight path dispersion would be sufficiently small to favor this method for achieving pin point accuracy.

(f.) Guidance Of A Projectile-Type Missile Along A Glide Or Skip Path

The development of a glide or skip path missile requires that all the propulsion, stabilization and guidance of a ballistic path missile be engineered first, since the ballistic technique must be utilized in accelerating the gliding missile and initially

GUIDANCE AND CONTROL (Cont'd.)

(f.) Guidance Of A Projectile-Type Missile Along A Glide Or Skip Path
(Cont'd.)

placing it on the proper path. Consequently, engineering a 1,000-mile ballistic missile automatically results in a tactical weapon potentially capable of more than twice its original range upon the development of adequate stabilization and guidance techniques for the added flight parameters.

The chart given on page 24 shows a comparison of the guidance methods which are potentially applicable to each of the two missile types. Of immediate note is the fact that the launching guidance methods applicable to the glide or skip path are basically identical to those applicable to the ballistic path. The glide missile requires, in addition, systems of midcourse and terminal guidance to place it on the target within the desired hit radius. Near the conclusion of the engineering program for the 1,000-mile tactical ballistic missile, developments to date in the midcourse and terminal guidance fields charted on page 24 would be analyzed critically and comparatively to select the proper developmental approach to the glide and skip path guidance problems.

BALLISTIC TRAJECTORY
MOST INVULNERABLE-DIFFICULT
TO INTERCEPT OR JAM

EXTERNAL

Control by Command.

Precise Adjustment of Velocity Vector.

Measurement of Azimuth and Elevation by Phase Angle comparison.

Range and Velocity directly obtainable by Doppler Methods.

All basic principles known and Prototype Equipment used to successfully guide C-46 Airplane in 1947.

Present system capable of 1 mile in 1000 accuracy.

Modifications for improving accuracy to 1 mile in 5000 have been determined and are practical.

INTERNAL

Integrating Accelerometers control Missile.

Subject to Cumulative Error which may be serious if carried over long time periods. (minutes)

Requires a Stable Platform of very high accuracy if no External Guidance is used.

System is one of the most desirable from Anti-jam qualities.

Good prospective system for future - particularly when coupled with an External System.

This type of the latter p an Internal initial Flight

Radio Method

Loran-Type
Hyper Grid

Radio Method
Slightly Lon

Wien -Type
Cyclan

Star Tracker

Celestial plied to thi weather, sta this missile

Inertial Sys

A system o may also be sile. Becau volved and o this method is probably the possibi cleanest an

Magnetic

Present M sulted in l this method proof, it a cation. Th of the Magn in its pres install.

CONSOLIDATED VULTEE AIRCRAFT CORPORATION
San Diego, California

Nov. 23, 1948

GLIDE OR SKIP PATH-TRAJECTORY
LONGEST RANGE FOR
GIVEN MASS RATIOMID COURSE
GUIDANCETERMINAL
GUIDANCE

Trajectory requires Guidance along
portion of the Flight Path. Either
External System may be used for
Phase.

Applicable for 1000 mile range -
System of this type subject to
jamming.

Which May be Applicable for
Ranges (1500 miles) -

Also subject to jamming and
possible positional ambiguities.

Navigation Methods may also be ap-
plicable to this type of missile. Limitations of
vertical etc. are the same for
others.

Internal Integrating Accelerometers
are not recommended for use in this type mis-
sile because of the long time intervals in-
crease for large Cumulative Error,
not immediately applicable. It
is one of the most Jam-proof and has
the advantage in time of being one of the
best universal systems.

Terminal Guidance System Tests have re-
vealed path width accuracies - Since
independent of range and is Jam-
proof is very desirable for this appli-
cation. Equipment depends upon knowledge
of the magnetic field in the target vicinity and
formation is rather bulky and hard to

This type of Trajectory practically demands some form of
Terminal Guidance, one of the most difficult phases of
guidance. Terminal Guidance in general requires some
unique characteristic of the target. It is difficult to
isolate and define any unique quality which may be common
to any and all desired targets. Listed below are some
of the Terminal Guidance Methods which might be applied
to a missile of this type:

Radar

Radar Target Seekers are most applicable against iso-
lated targets such as ships, airplanes etc. Without
rather complicated auxiliary devices they are not in
general suitable for use against cities and similar land
targets. (See Map Matching below) Radar Type Target
Seekers are a very excellent choice if it is practical
to plant Beacons in the Target Area. Coded units could
be planted by Ground Agents or Dropped by Air.

Infra-Red

In general Infra-Red Seekers are too slow and insensi-
tive for satisfactory application. Further, with exist-
ing types it is difficult to obtain satisfactory defini-
tion of targets from the background. This is particu-
larly true of cities. However, it offers definite possi-
bilities for future development.

Map Matching

Optical methods of Map Matching or Seekers which use
Visual Spectrum are very limited in their utility and are
vulnerable to camouflage - In general not recommended for
this application. Map Matching and Off-set Matching when
applied to a Radar Seeker offer the best solution in this
class of Terminal Guidance Equipment. This method in
general requires considerable reconnaissance of the tar-
get area and vicinity.

Magnetic Signature

It has been observed that Metropolitan and Industrial
Areas possess characteristic Magnetic Anomalies. These
are in general very unique for each locality and are vir-
tually impossible to hide or disguise. For Targets of
Industrial or Metropolitan nature, this characteristic
Magnetic "Signature" offers a very excellent possibility
for Terminal Guidance of missiles of this class.

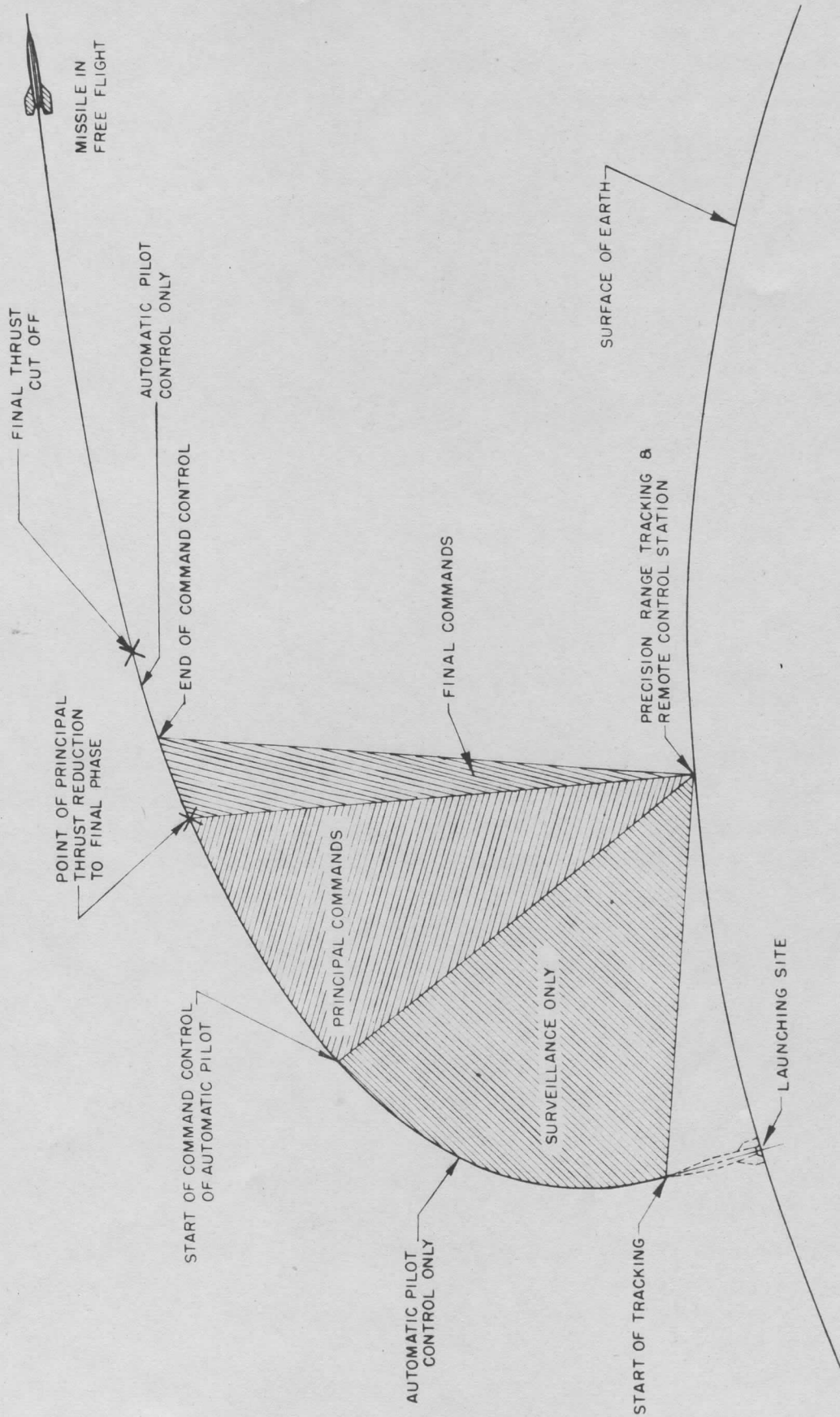

FIG. 1 - PROGRAM OF POWER PORTION OF FLIGHT

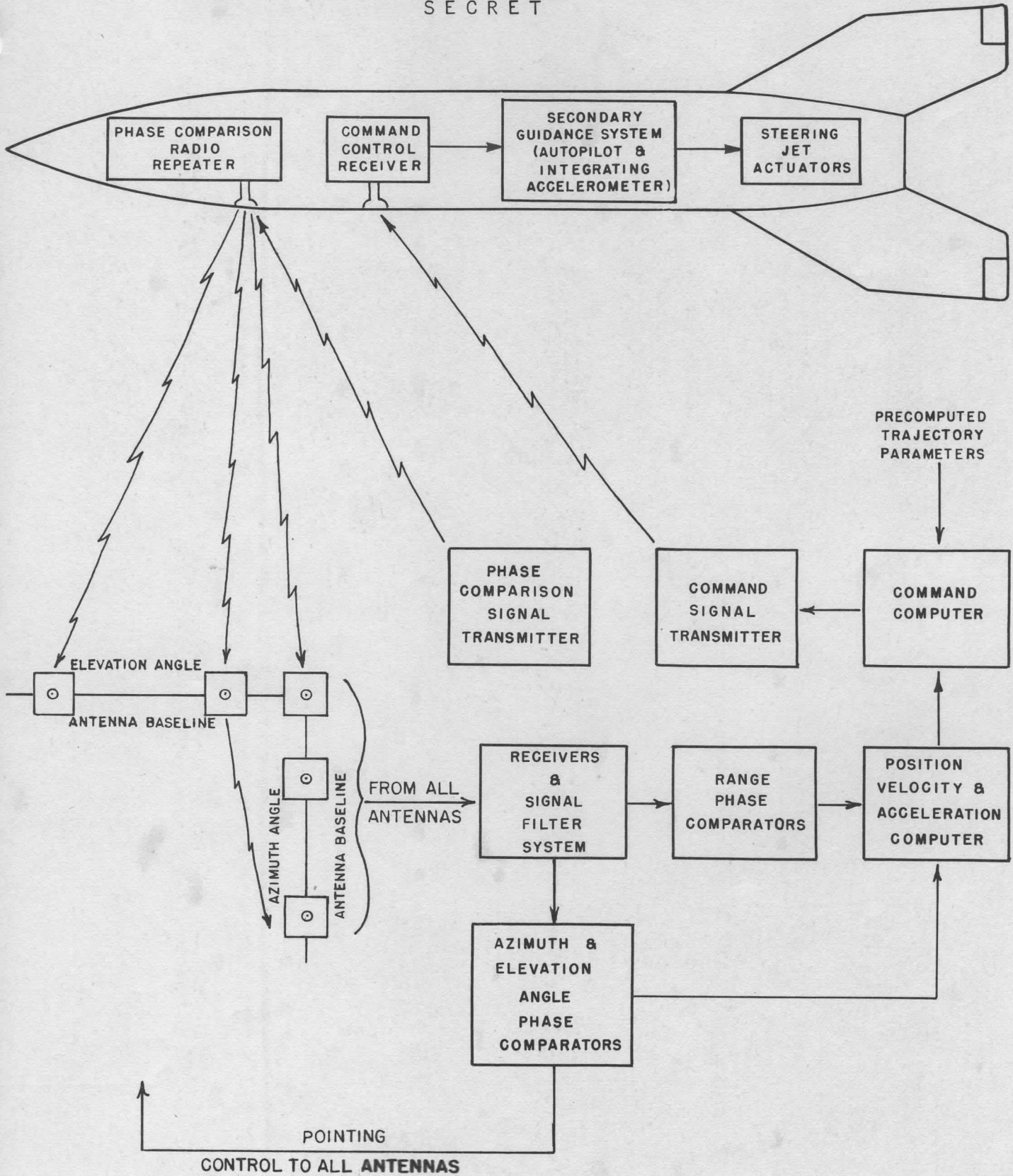

FIG. 2 - BLOCK DIAGRAM OF PRECISION TRACKING AND GUIDANCE SYSTEM

ANALYSIS
PREPARED BY
CHECKED BY
REVISED BY

CONSOLIDATED VULTEE AIRCRAFT CORPORATION

SAN DIEGO DIVISION

SECRET

PAGE 27

REPORT NO ZP-48-35003

MODEL

DATE Nov. 23, 194

TESTING FACILITIES

TESTING FACILITIES

Proposed static testing facilities consist of additions to the present MX-774 static test site at Point Loma. This site has proven to be very efficient. Existing blockhouse, water supply, electrical power, and roadways can be utilized.

The tower and supporting gimbal allows approximately ten degrees freedom of pitch, yaw and roll. The proposed tower is constructed in the sections and is located on a circular cement slab used as a thrust deflector. Fire fighting and cooling water supply controls are located in the blockhouse. Instrumentation located in the blockhouse is connected to the missile through a tunnel. Electric hoists are provided for lifting the missile and for elevating personnel and equipment.

Existing testing facilities located on the harbor shore at San Diego also, are available for component testing.

SECRET

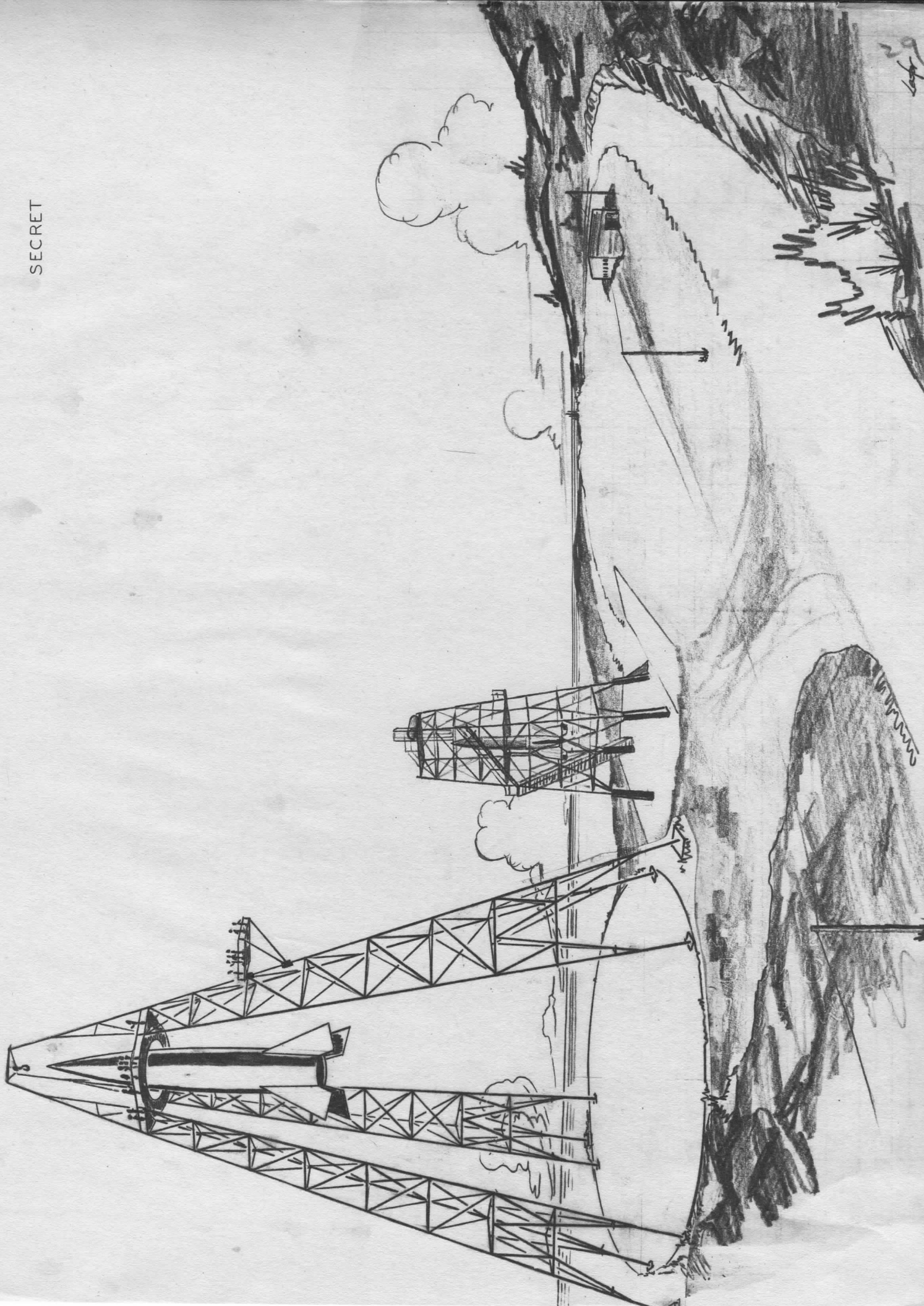

ANALYSIS
PREPARED BY
CHECKED BY
REVISED BY

CONSOLIDATED VULTEE AIRCRAFT CORPORATION

SAN DIEGO DIVISION

SECRET

PAGE 30

REPORT NO. ZP-48-350

MODEL

DATE Nov. 23, 1947

FUTURE DEVELOPMENTS

SECRET

SECRET

FUTURE DEVELOPMENTS

The potentialities of the ballistic type oxygen-alcohol powered missile are limited. To demonstrate these limitations a study was made of a 6,000 pound payload, 250,000 pound gross weight alcohol-oxygen missile which is considered to be the maximum size practical with present day engines. A calculated range of 2113 miles, based on the weight statement shown on page 34, was obtained. The configuration upon which this performance is based is similar to that of the 6,000 lb, 1,000 mile missile described in Appendix A. The power plant would consist of five (5) V-2 type engines of 75,000 pounds thrust each such as are now under development by North American Aviation Inc.

Several avenues are worthy of investigation in approaching the ultimate goal of delivering a 6,000 pound warhead 5,000 miles. Those showing most promise at present include: (1) development of new fuels, and (2) investigation of "glide" and "skip" trajectories as proposed in Project RAND.

1. New Fuels:

The obvious advantages of high specific impulse fuels warrant thorough investigation of all possibilities along these lines. Design studies have been made of missiles based on Boronhydride and Hydrogen-Oxygen fuels capable of delivering a 5,000 pound warhead 5,000 miles. The configurations used in these studies are presented in CVAC Report DEVF 1496-11. Further studies indicate a Hydrogen-Oxygen missile of 117,400 pounds gross weight capable of delivering a 5,000 pound warhead 5,000 miles on a ballistic trajectory. Page 33 gives a weight statement for this missile. By the use of a "glide" or "skip" trajectory as discussed in the following paragraph, a much lower gross weight can be expected. Project RAND Report RA 15064 indicates that with the use of the "glide" trajectory an 82,000 pound Hydrogen-Oxygen missile will deliver a 6,000 pound warhead 5,000 miles.

2. Trajectory Investigation:

As indicated in Project RAND investigations, "glide" and "skip" trajectories may result in considerably increased ranges over the ballistic type trajectory. A preliminary check indicates that the range of the 1,000 mile, 6,000 pound warhead missile described in Appendix "A" may be more than doubled by using the "glide" trajectory. Gains of even greater proportions may be expected with longer range missiles.

FUTURE DEVELOPMENTS (Cont' d)

2. Trajectory Investigation: (Cont' d)

Thorough aerodynamic and guidance studies will be required to fully utilize the potentialities of these trajectories. The very high velocities and extreme low densities involved make present-day wind tunnel techniques inadequate for the study of aerodynamic characteristics of this type missile. Gathering of aerodynamic data by means of flight test models is then indicated. Such models could be launched from the MX-774 test vehicles.

WEIGHT STATEMENT

HYDROGEN-OXYGEN MISSILE

5,000 LB WARHEAD - 5,000 MILES

	<u>TAKE OFF WEIGHT</u>	<u>2nd STAGE WEIGHT</u>
Warhead + Ht. Protection	6750	6750
Fixed Equip.	2035	830
Structure	8295	2050
Power Plant	<u>3620</u>	<u>670</u>
Wt. Empty	20,700	10,300
Fuel	<u>96,700</u>	<u>30,100</u>
Gross Wt.	117,400	40,400

WEIGHT STATEMENT

250,000 POUND ALCOHOL-OXYGEN

TWO STAGE MISSILE

	<u>TAKE OFF WEIGHT</u>	<u>2nd STAGE WEIGHT</u>
Payload	6370	6370
Body Group	6090	5210
Power Plant	9800	2250
Fixed Equipment	<u>1080</u>	<u>330</u>
Weight Empty	23,340	14,160
Fuel	126,660	27,840
Gross Weight	250,000	42,000
Wt. at End 1st Stage	51,170	
m ₁	4.88	
m ₂	1.51	
m ₁ m ₂	7.35	

ANALYSIS
PREPARED BY
CHECKED BY
REVISED BY

CONSOLIDATED VULTEE AIRCRAFT CORPORATION

SAN DIEGO DIVISION

SECRET

PAGE 35

REPORT NO. ZP-48-3500

MODEL

DATE Nov. 23, 1944

ECONOMIC CONSIDERATIONS

ECONOMICS OF ROCKET-TYPE MISSILES

Evaluation of missiles on the basis of overall gross weight required to accomplish a given mission is misleading if the cost per ton mile of explosive delivered is to be considered. This type of evaluation fails to take into account the fact that a very large portion of the total gross weight of a rocket type missile consists of fuel which costs much less per pound than air frame, guidance, power plant, etc. Thus, a rocket missile can have a much higher gross weight than other types and still cost no more to fire.

To illustrate the effect of the total gross weight breakdown on cost, a preliminary design was made for a rocket-type missile to carry a payload of 3,000 pounds a distance of 1,000 miles. This design study is compared to a similar missile now being designed under Project MX-770. The cost per pound used in this comparison for air frame, power plant and guidance represents an estimate of costs that could be made good at the present time in lots of 100 missiles. These estimates are based on CVAC experience to date in the guided missile field. The cost of propellants represents current prices in car load lots. The results of this comparison are shown in the table below.

	Unit Cost \$/lbs	Rocket Missile		MX-770	
		Weight Lbs.	Cost \$	Weight Lbs.	Cost \$
Airframe	27.00	2,361	63,700.00	10,527	285,000.00
Power Plant	80.00	1,100	88,000.00	900	72,000.00
Guidance	100.00	300	30,000.00	330	33,000.00
Payload	--	3,000	---	3,000	
Total W. Empty	--	6,761	\$181,700.00	14,757	\$390,000.00
Oxygen	0.04	21,500	862.00	10,800	432.00
Alcohol	0.10	17,150	1,715.00	8,600	860.00
H ₂ O ₂	0.16	790	126.00	393	63.00
Gas	0.025	--		10,100	252.00
Total Fuel	--	39,500	\$ 2,703.00	29,793	\$ 1,607.00
Total	--	46,261	<u>\$184,403.00</u>	44,550	<u>\$391,607.00</u>

In order to study the place of the rocket powered missile in the long range missile field when improved fuels and improved trajectories are developed, a comparison has been made with design studies now under way on Project MX-775.

SECRET

The first comparison is between a 5,000 pound payload, 5,000 mile range, twin-engine, turbo jet powered, delta wing missile and a hydrogen-oxygen powered rocket type missile flying a true ballistic trajectory. The price assumed for the turbo jet engine assumes that the same engine would be used in piloted aircraft and that quantity production engines would be available for the first 100 missiles. The price assumed for hydrogen is taken from Rand studies and represents deliveries in large quantities. The cost of launching the turbo jet powered missile has been completely neglected and will add materially to the cost of this type missile.

In order to evaluate the effect of perfecting the maximum L/D glide power trajectory on the cost of delivering the 5,000 pound payload a distance of 5,000 miles, a hydrogen-oxygen powered, wingless missile was picked from the Rand study report RA-15064. This missile is compared with both the turbo jet missile and the hydrogen-oxygen ballistic trajectory missile in the table on page 38

SECRET

PAYLOAD 5,000 - RANGE 5,000 MILES

MX-775

Ballistic Rocket Missile

Rocket Missile

Glide path Rocket Missile

	Unit Cost \$/lb	Weight lbs	Cost \$	Weight lbs	Cost \$	Weight lbs	Cost \$
Airframe	27.00	19,870	536,000.00	13,250	358,000.00	5,330	144,000.00
Rocket Powerplant	80.00	---	---	2,160	173,000.00	1,500	120,000.00
Turbojet Powerplant	25.00	10,000	250,000.00	---	---	---	---
Guidance	100.00	400	40,000.00	330	33,000.00	400	40,000.00
Payload	---	5,000	---	5,000	---	5,000	---
Total W. Empty	---	35,270	\$826,000.00	---	\$564,000.00	12,230	\$304,000.00
Oxygen	0.04	---	---	75,813	3,032.00	45,300	1,810.00
Hydrogen	0.50	---	---	18,953	9,477.00	11,300	5,650.00
H2O2	0.16	---	---	1,934	310.00	1,130	187.00
Gasoline	0.025	48,538	1,215.00	---	---	---	---
Total Fuel	---	48,538	\$ 1,215.00	96,700	\$ 12,819.00	57,770	\$ 7,647.00
Total	---	83,808	\$827,215.00	117,410	\$576,819.00	70,000	\$311,647.00

ANALYSIS
PREPARED BY
CHECKED BY
REVISED BY

CONSOLIDATED VULTEE AIRCRAFT CORPORATION

SAN DIEGO DIVISION

SECRET

PAGE 39

REPORT NO. ZP-48-350

MODEL APPENDIX

DATE NOV. 23, 1948

APPENDIX A

DESIGN DATA

FOR

6000 LB WARHEAD, 1000 MILE MISSILE

SECRET

INTRODUCTION

Appendix A presents numerical data and methods of analysis on which the design and performance of the 6000 lb., 1000 mile missile were based. It consists of weight and balance data, stability and pressure distribution analysis, structural analysis and performance computations. Obviously all the above analyses are mutually interdependent, the results of each one depending on the results of the others. Inasmuch as this work was done in a very limited time, and inasmuch as a design of this nature is the end result of a series of successive refinements, slight discrepancies may appear between the various sections. It is felt, however, that these unavoidable discrepancies have an insignificant influence on the final predicted performance.

STABILITY AND CONTROL

(6000 LB. WARHEAD, 1000 MILE MISSILE)

(a) General

The 6000 lb. warhead, 1000 mi. missile has four modified arrowhead type fins for stabilizing surfaces. Since the missile is symmetrical about the longitudinal axis, it is equally stable in yaw and in pitch.

It was possible to design relatively small fins (15 sq. ft. per panel on the booster stage) due to both the excellent aerodynamic characteristics of the modified arrowhead fin and the advantage gained in center of gravity position by placing the 6000 lb. warhead in the nose of the missile. A minimum margin of static longitudinal stability of two percent body length at the most critical stability condition was used as a basis of determining the fin areas.

The fins of this missile will be completely dropped along with four 20,000 pound thrust rocket motors and related equipment at the end of the booster stage of operation. The fins are not required in the final stage due to the forward position of the center of gravity, thus causing the body alone to be stable without fins. It of course should also be noted that the very low density of the upper atmosphere would result in stabilizing surfaces being practically ineffective.

The control system of the booster stage is composed of eight pivoted rocket motors that operate by the following schedule.

		Angles of Deflection			
		Total	Pitch	Yaw	Roll
Pitch - Roll					
2 (2,000 lb. Thrust)	Rockets	15°	5°	0	10°
2 (20,000 lb. Thrust)	Rockets	5°	2°	0	3°
Yaw					
2 (2,000 lb. Thrust)	Rockets	15°	0	15°	0
2 (20,000 lb. Thrust)	Rockets	2°	0	2°	0

STABILITY AND CONTROL

(6000 LB. WARHEAD, 1000 MILE MISSILE)

(a) General (Cont'd)

The final stage control system operates the same as above less the 20,000 lb. thrust rocket motors which are ejected at the end of the booster stage.

This method of control has proven very effective on the MX-774 test vehicle flights conducted by Convair.

The large pitch and yaw control rockets are limited to two degree deflections in order to limit the maximum trim angle to three degrees at the point of maximum dynamic pressure, for structural reasons.

The roll control rockets are capable of trimming out rolling moments inducted by misalignment of the fins due to manufacturing tolerance as well as compensating for outside wind disturbances which might tend to roll the missile.

(b) Normal Force and Center of Pressure Characteristics

1. Body

The lift distributions over the body at various Mach numbers were estimated from the theoretical linearized method presented in reference 1. The lift distribution is represented by a plot of $F_n R_n$ vs X (see page 47) where

$$\frac{dC_{NB}}{d\alpha} = \frac{4}{\beta} \sum F_n R_n \Delta X$$

The center of pressure is easily obtained by

$$\frac{X_B}{l} = \frac{R \sum F_n R_n X \Delta X}{l \sum F_n R_n \Delta X}$$

where $F_n R_n X_n$ vs X is obtained from page 48 and R is the maximum radius of the body (38 inches) and l is the body length (744 inches).

Plots of center of pressure location aft of the nose, $\frac{X_B}{l}$ and normal force coefficient, $dC_N/d\alpha$, versus Mach number for the body alone are presented on page 49.

STABILITY AND CONTROL

(6000 LB. WARHEAD, 1000 MILE MISSILE)

(b) Normal Force and Center of Pressure Characteristics (Cont'd)

2. Fin

The fin normal force and center of pressure characteristics were calculated by the method outlined in reference 2. However since these calculations did not include the increase in $dC_{NF}/d\alpha$ due to body carry-over, the above calculated values were increased by a conservative factor of 1.1 (see reference 3) to account for the added effect.

Plots of center of pressure location forward of the base, X_F/l , and normal force coefficient of one fin $dC_{NF}/d\alpha$ versus Mach number for fin alone are presented on page 50.

3. Complete Missile

The center of pressure location can be calculated by taking moments about the center of pressure of the fin, or

$$\frac{X}{l} = \frac{\left(1 - \frac{X_B}{l} - \frac{X_F}{l}\right) dC_{NB}/d\alpha}{2 dC_{NF}/d\alpha + dC_{NB}/d\alpha} + \frac{X_F}{l}$$

The variation of center of pressure with Mach number for the complete missile is presented on page 51 along with the variation of center of gravity. This shows the margin of static longitudinal stability of various Mach numbers.

4. Trim Angles of Attack

The trim angles of attack for the booster stage were calculated with full rocket deflection of 2° per rocket for maximum range conditions by

$$\alpha_{\text{trim}} = \frac{C_{m_J}}{dC_m/d\alpha}$$

where $C_{m_J} = \frac{T_i \sin 2^\circ (X_{c.g.} - X_J)}{g S_B d}$

and $\frac{dC_m}{d\alpha} = \frac{(2 dC_{NF}/d\alpha + dC_{NB}/d\alpha)(X_{c.g.} - X)}{d}$

STABILITY AND CONTROL

(6000 LB. WARHEAD, 1000 MILE MISSILE)

(b) Normal Force and Center of Pressure Characteristics (Cont'd)

4. Trim Angles of Attack (Cont'd)

$$T_1 = 40,000 \text{ lb.}$$

$$S_B = 31.5 \text{ sq.ft.}$$

$$d = 6.33 \text{ ft.}$$

$$X_{c.g.} = \text{distance from base of body to C.G.-ft.}$$

$$X = \text{distance from base of body to C.P.-ft.}$$

The variation of trim angle of attack with Mach number is presented on page 53.

STABILITY AND CONTROL
(6000 LB. WARHEAD, 1000 MILE MISSILE)

REFERENCES

1. Beskin, L.: Tabular Forms for the Application of H. S. Tsien's Method to the Calculation of the Lift and Moment Coefficients for Bodies of Revolution at Supersonic Velocities. APL/JHU CM-248. 17 May 1946.
2. Patterson, W. H.: Final Aerodynamics Report of Single Stage Supersonic Test Vehicle (MX-774) C.V.A.C. ZA-6002-002, 30 January 1948.
3. Patterson, W. H., Shutts, W. H., Dore, F., and Mardrosian, M.: Review of Aberdeen Supersonic Wind Tunnel Tests of the GAPA Missile Models and Correlation with Theory. C.V.A.C. ZA-4033-001, 30 April 1948.

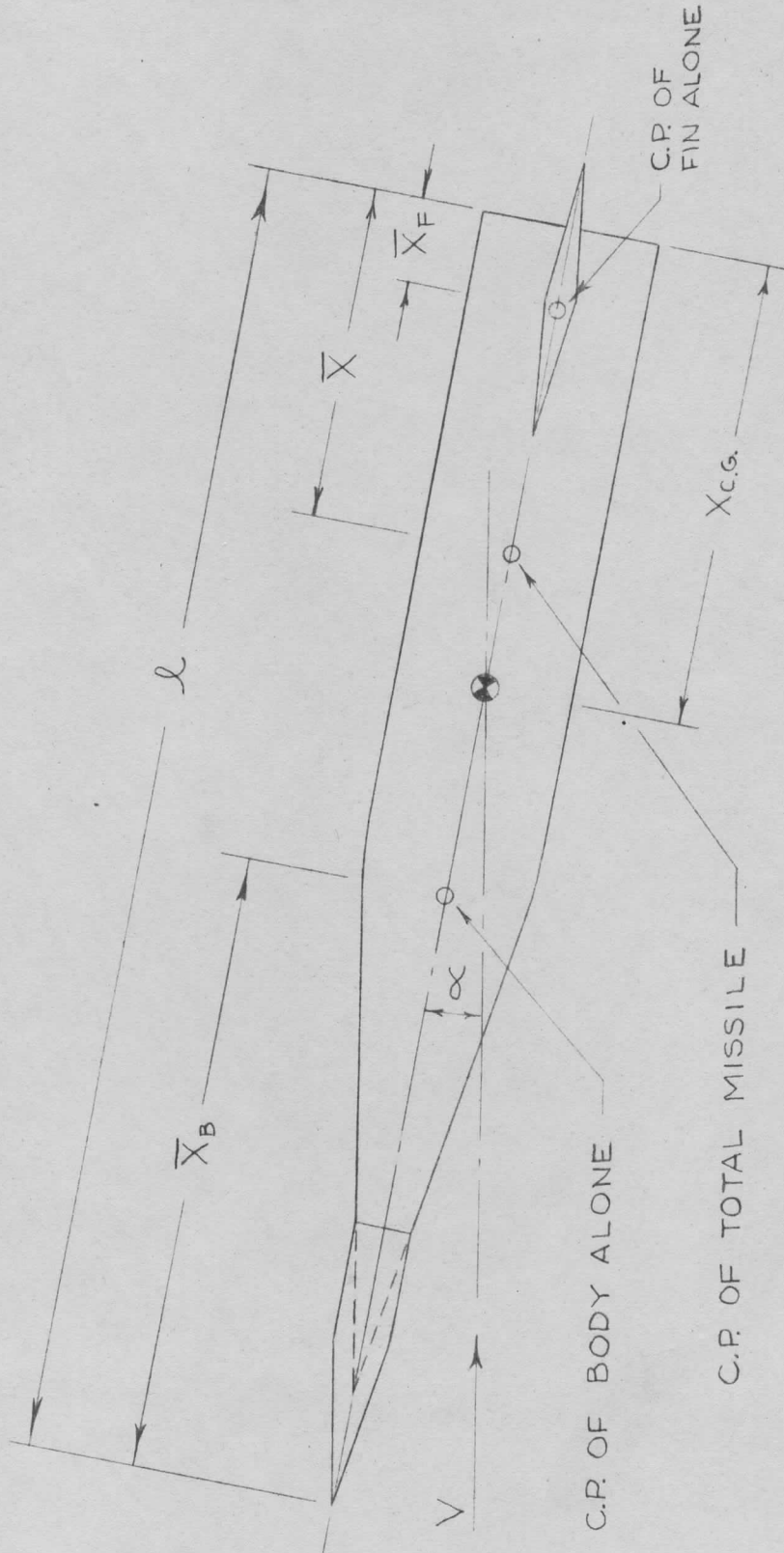

NOTATION USED IN CALCULATING
STATIC LONGITUDINAL STABILITY

S+C 6000

5+C 6000

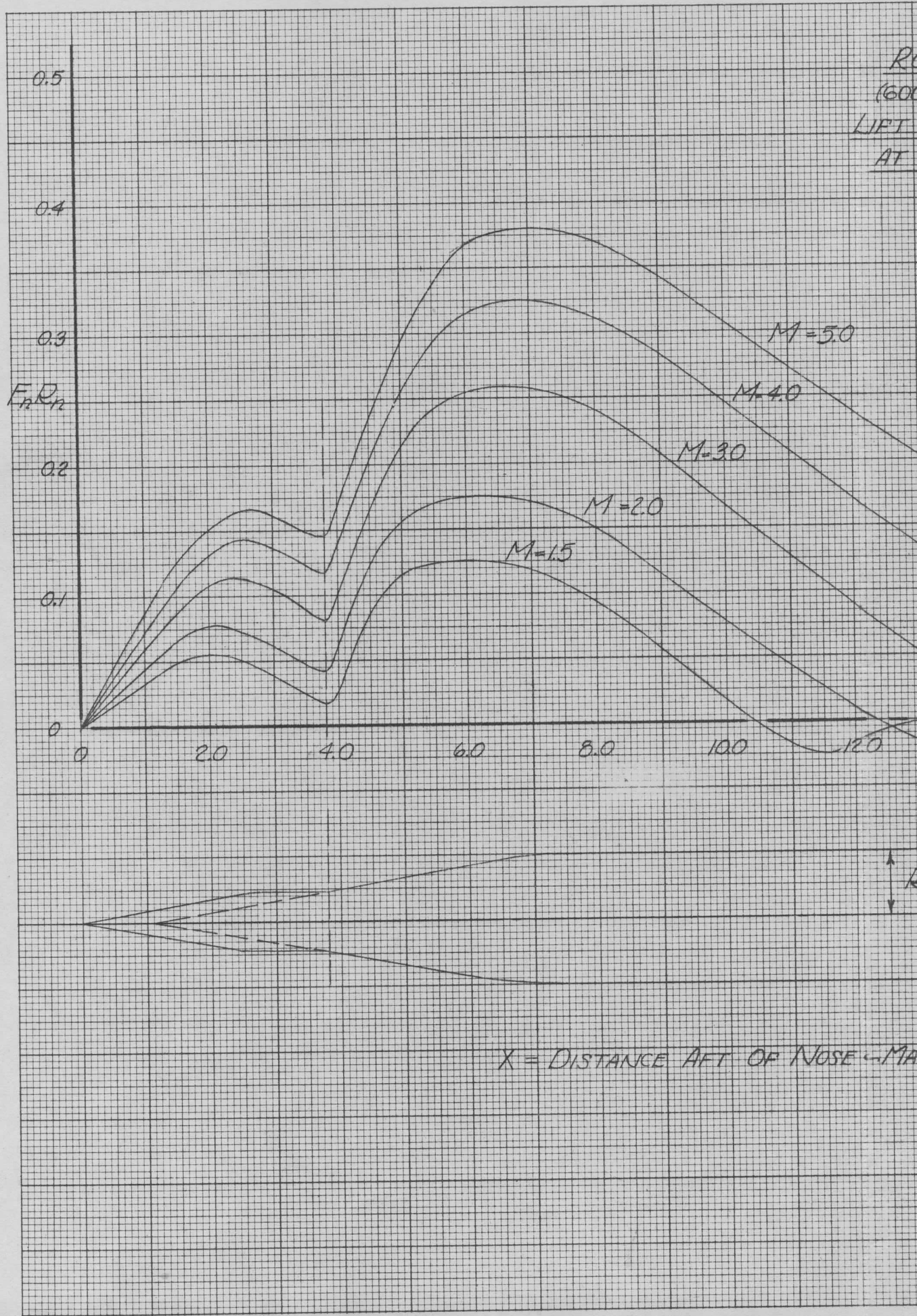

RE
(600
LIFT
AT

X = DISTANCE AFT OF NOSE - MA

BUCKET TYPE MISSILE
(10 LB. WARHEAD-1000 MI.)
DISTRIBUTION ON BODY ALONE
VARIOUS MACH NUMBERS

$$\sum F_n R_n \Delta x = a/a_0$$

$$a = dC_n/d\alpha$$

$$a_0 = 4/\beta$$

$$\beta = \sqrt{M^2 - 1}$$

$$C_{NB} = N_B/qS_B$$

$$R_0 = \text{MAXIMUM RADIUS} = 38''$$

$$R = \text{LOCAL RADIUS} - \text{IN.}$$

$$R_N = R/R_0 \text{ AT } \pi^{\text{th}} \text{ STATION}$$

$$\alpha = \text{ANGLE OF ATTACK} - \text{RADIAN}$$

$$M = \text{MACH NUMBER}$$

$$N_B = \text{BODY NORMAL FORCE} - \text{LB.}$$

$$q = \text{DYNAMIC PRESSURE} - \text{LB./SQ. FT.}$$

$$S_B = \text{MAXIMUM BODY CROSS-SECTIONAL AREA} = 31.5 \text{ SQ. FT.}$$

$$L = 62.0 \text{ FT.}$$

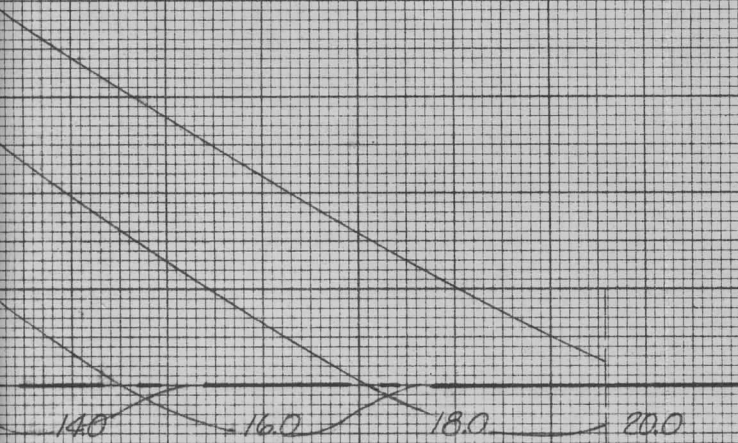

MAXIMUM RADII

Nov. 23, 1948

CALCULATED BY		CONSOLIDATED AIRCRAFT CORPORATION LINDBERGH FIELD, SAN DIEGO, CALIF.	PAGE
TRACED BY			DOC. NO.
CHECKED BY			MODEL
APPROVED BY			
APPROVED BY			

5+C 6000

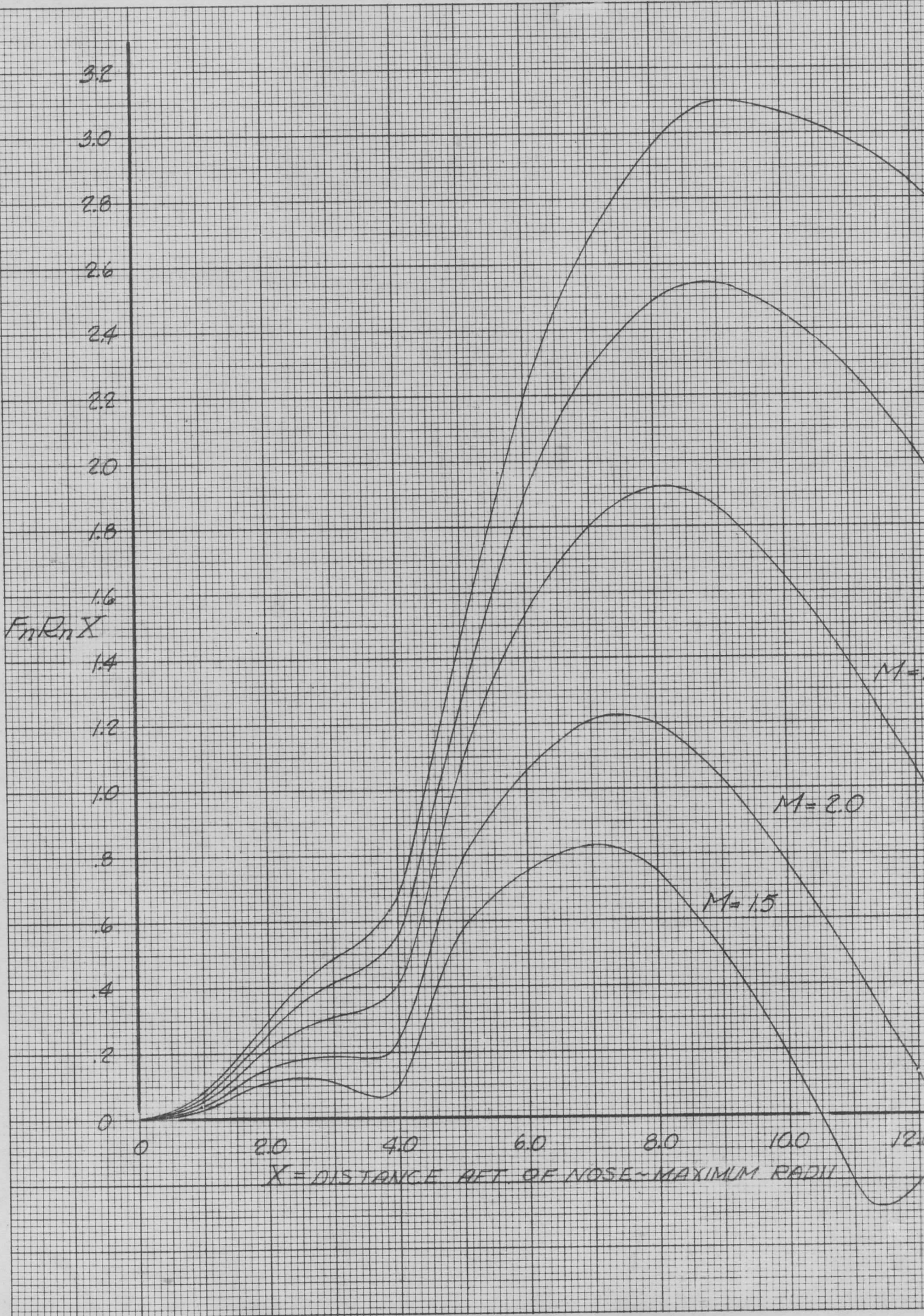

ROCKET TYPE MISSILE
(6000 LB. WARHEAD ~ 1000 MI.)
MOMENT DISTRIBUTION ON BODY ALONE AT
VARIOUS MACH NUMBERS

$$\frac{dC_{mB}}{d\alpha} = \frac{2}{\beta} \sum F_n R_n \sin \alpha$$

M=5.0

$$C_{mB} = N_B \bar{X}_B / \beta S_B d$$

R₀ = MAXIMUM RADIUS = 38 IN.

R = LOCAL RADIUS ~ 1 IN.

R_n = R/R₀ AT nth STATION

α = ANGLE OF ATTACK ~ RADIANS

M = MACH NUMBER

$$\beta = \sqrt{M^2 - 1}$$

N_B = BODY NORMAL FORCE ~ LBS.

q = DYNAMIC PRESSURE ~ LB./SQ. FT.

S_B = MAXIMUM BODY CROSS-SECTIONAL
AREA = 31.5 SQ. FT.

d = MAXIMUM BODY DIAMETER = 3 FT. FT.

 \bar{X}_B = LONGITUDINAL DISTANCE
MEASURED AFT OF NOSE
TO C.P. BODY ~ FT.

L = 62.0 FT.

M=4.0

140

160

180

200

Nov. 23, 1948

CALCULATED BY

TRACED BY

CHECKED BY

APPROVED BY

APPROVED BY

PAGE

DOC. NO.

MODEL

CONSOLIDATED AIRCRAFT CORPORATION
LINDBERGH FIELD, SAN DIEGO, CALIF.

SECRET

ROCKET TYPE MISSILE

(6000 LB WARHEAD-1000 MI.)

VARIATION OF CENTER OF PRESSURE LOCATION AND
 NORMAL FORCE COEFFICIENT PER DEGREE ANGLE OF
 ATTACK WITH MACH NUMBER FOR BODY ALONE.

x_B = C.P. LOCATION FOR BODY ALONE
 MEASURED AFT OF NOSE - FT.

l = BODY LENGTH = 62.0 FT.

C_{NB} = $N_B / q S_B$

N_B = BODY NORMAL FORCE - LB.

q = DYNAMIC PRESSURE - LB./SQ.FT.

S_B = MAX. BODY CROSS-SECTION AREA - 31.5 SQ.FT.

α = ANGLE OF ATTACK - DEG.

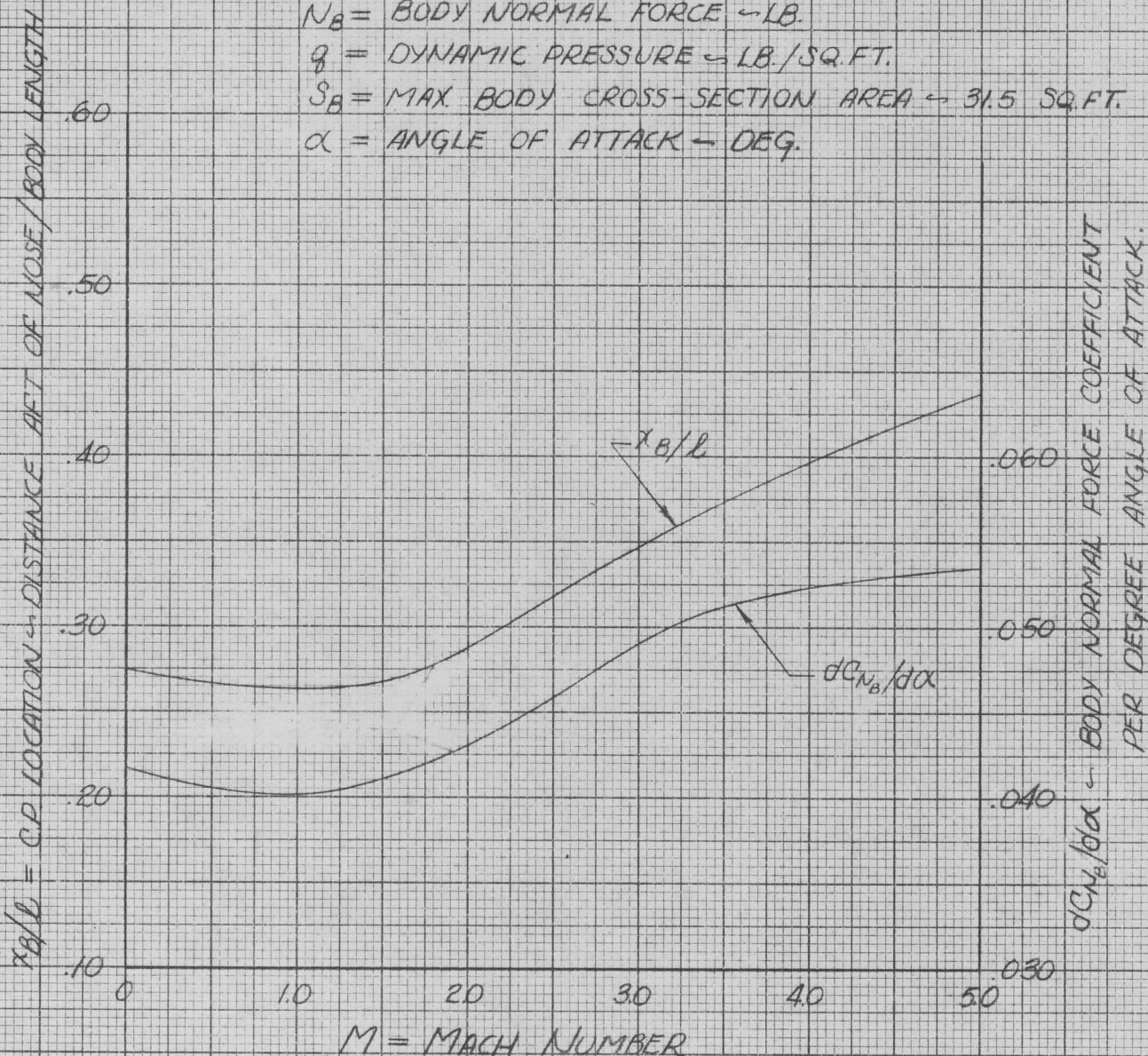

NO. 329-11. 10 x 10 to the first inch. 2 1/2 inch lines secured.
 Engraving 7 x 10 in.
 MADE IN U.S.A.

5+5
 KENNEL & ESSER CO.

SECRET

Nov. 27, 1948

SECRET

ROCKET TYPE MISSILE

(6000 LB. WARHEAD ~ 1000 MI)

VARIATION OF CENTER OF PRESSURE LOCATION AND
NORMAL FORCE COEFFICIENT PER DEGREE ANGLE OF
ATTACK WITH MACH NUMBER FOR FIN ALONE
(INCLUDING UPWASH AND BODY CARRY-OVER)

X_F = C.P. LOCATION FIN MEASURED FROM
BASE OF BODY ~ FT.

l = BODY LENGTH = 62.0 FT.

$C_{NF} = N_F / q S_B$

N_F = FIN NORMAL FORCE ~ LB.

q = DYNAMIC PRESSURE ~ LB./SQ. FT.

S_B = MAX. BODY CROSS-SECTIONAL AREA = 31.5 SQ. FT.

α = ANGLE OF ATTACK ~ DEG.

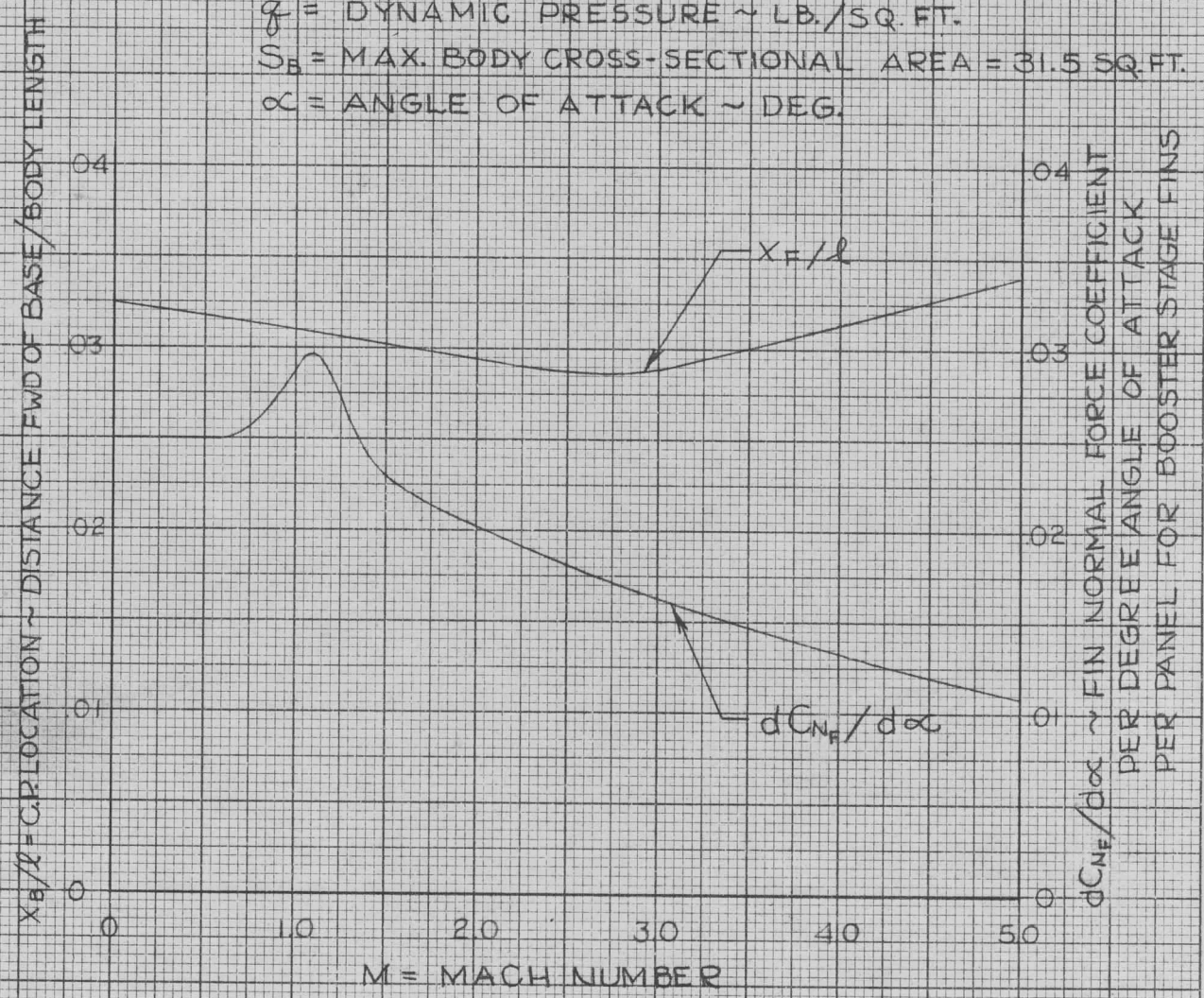

SECRET

Nov. 23, 1948

NO. 329-11. 10 X 10 to the first inch, 2 1/2 inch lines secured.

KENNELT & ESSER CO.

54C 6000

SECRET

ROCKET TYPE MISSILE
 (6000 LB WARHEAD ~ 1000 MI.)

CENTER OF PRESSURE AND CENTER OF GRAVITY LOCATION
 AS A FUNCTION OF MACH NUMBER FOR MAXIMUM RANGE CONDITION

\bar{x} = C.P. LOCATION MEASURED FROM
 BASE OF BODY ~ FT.

x_{cg} = C.G. LOCATION MEASURED FROM
 BASE OF BODY ~ FT.

l = BODY LENGTH = 62 FT.

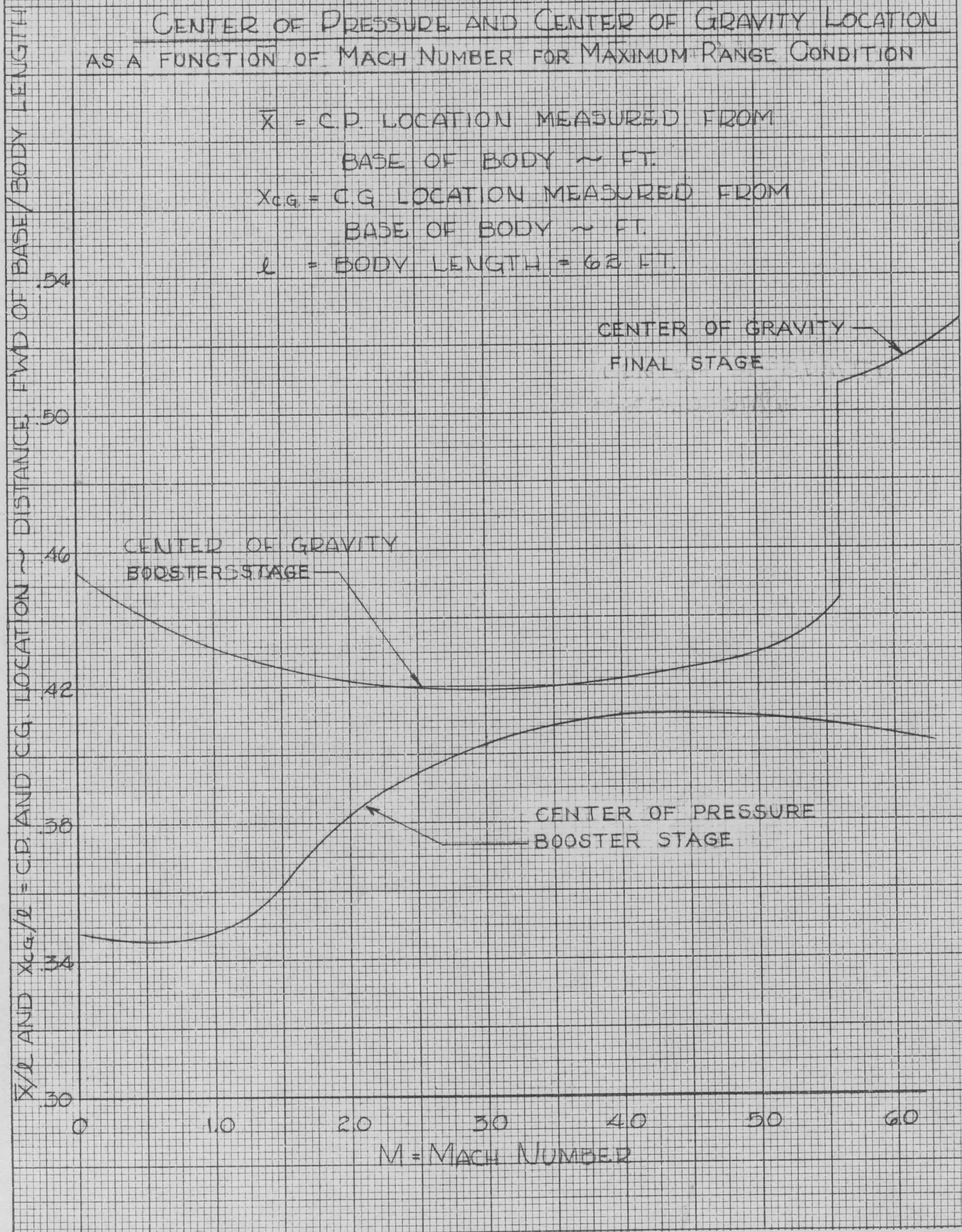

CHARLES BRUNING COMPANY, INC.
 30 x 50 to the inch.

NO. 200-30

6000 54 C

DATA SHEETS

SECRET

Nov. 23, 1948

SECRET

ROCKET TYPE MISSILE
(6000 LB. WARHEAD ~ 1000 MI.)

PITCHING MOMENT COEFFICIENT DUE TO ROCKET DEFLECTION
AS A FUNCTION OF MACH NUMBER FOR MAXIMUM RANGE CONDITION

$$C_{m_j} = M_j / q S_B d$$

q = MAXIMUM RANGE DYNAMIC PRESSURE ~ LBS/SQ. FT.

S_B = MAXIMUM BODY CROSS-SECTIONAL AREA ~ 31.5 SQ. FT.

M_j = MOMENT DUE TO ROCKET DEFLECTION

$$= (X_{CG} - X_J) \frac{T}{2} \sin \phi_J$$

T = TOTAL ROCKET THRUST OF MISSILE ~ LB.

ϕ = ROCKET DEFLECTION ANGLE = 2°

d = MAXIMUM BODY DIAMETER = 0.33 FT.

X_{CG} = C.G. LOCATION MEASURED FROM BASE OF BODY - FT.

X_J = LONGITUDINAL DISTANCE FROM BASE OF BODY
TO ϕ ROCKET HINGE = 1.00 FT.

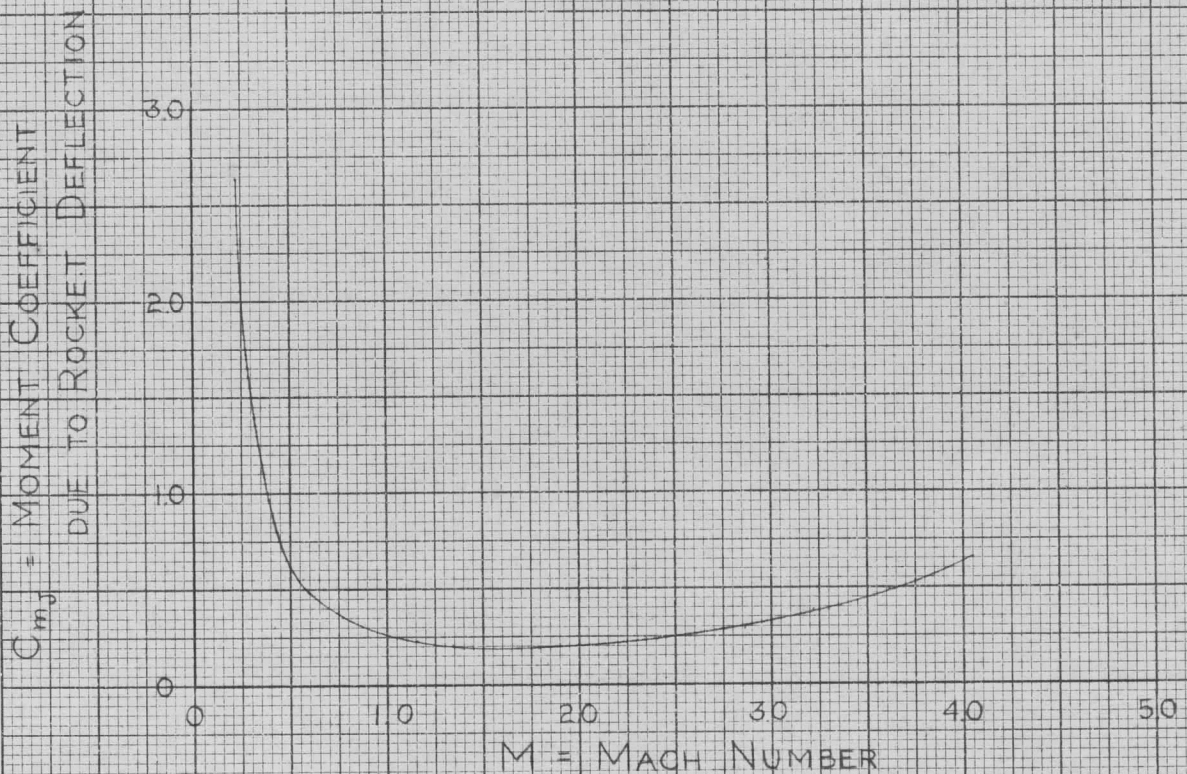

SECRET

Nov. 23, 1948

NO. 388-117 10 X 10 for the part inch, 2 1/2 inch square

ENGLAND 1 X 10 1/2
MADE IN U.S.A.

KENNEL & ESSER CO.

54C 6000

SECRET

ROCKET TYPE MISSILE
(6000 LB WARHEAD ~1000 MI)

TRIMMED ANGLE OF ATTACK IN PITCH AS A
FUNCTION OF MACH NUMBER FOR MAXIMUM RANGE CONDITION

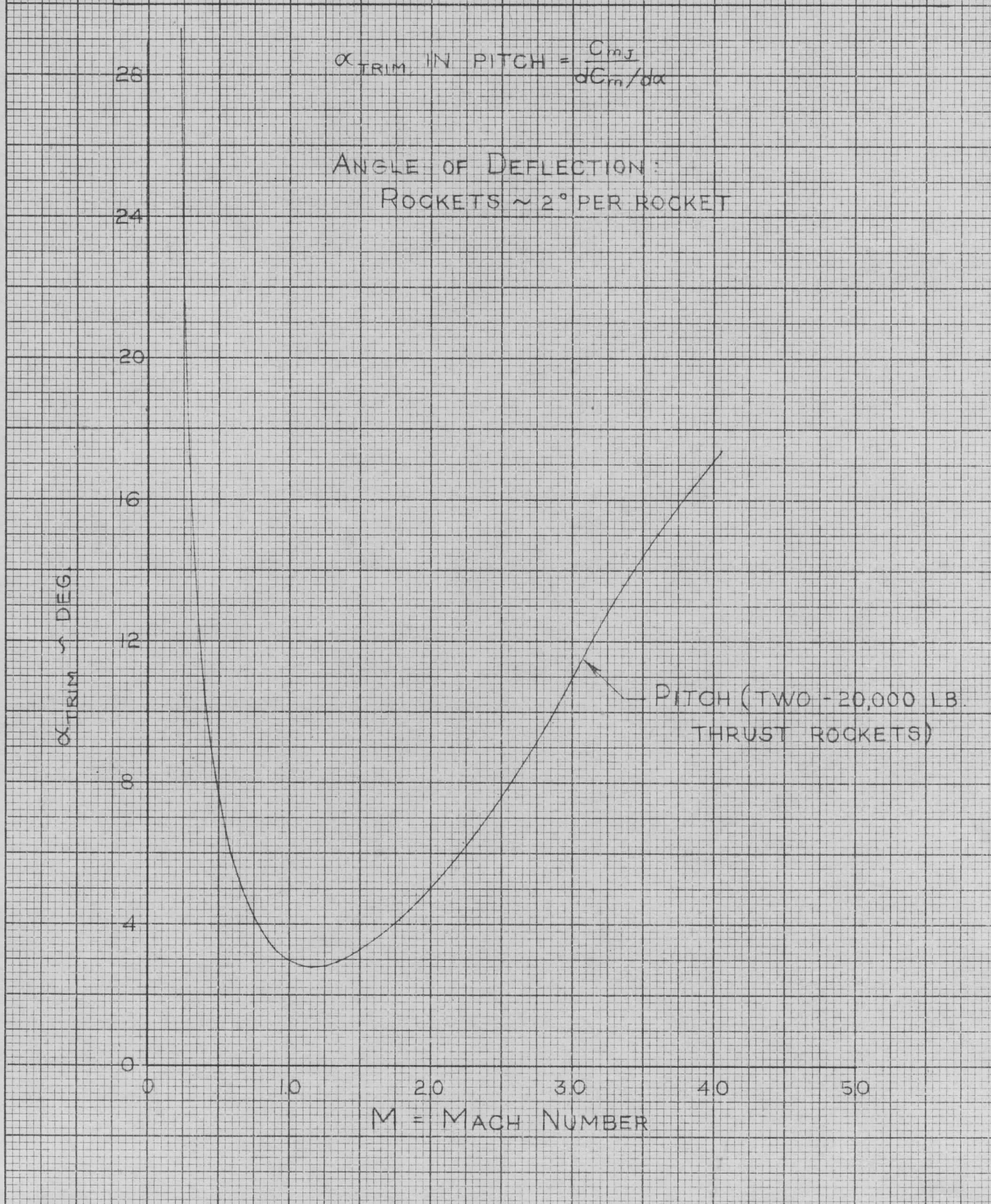

NO. 320-11. 10 X 10 to the half inch. 2 1/2 times scooped.
ENLARGED 1 X 10 in.
MADE IN U.S.A.

KENNEL & ESSER CO.
0009 245

SECRET

Nov. 23, 1948

WEIGHT JUSTIFICATION AND ANALYSIS

The 6000 lb. warhead, 1000 mile range missile is estimated at a gross weight (Stage I) of 73,484 lbs. and at a c.g. of 405.7 inches from the nose (Sta. 0). Gross weight at Stage II is 16,351 lbs. at a c.g. of 317.8 inches.

Weight empty including payload of 6,240 lbs. (Stage I) is estimated to be 11,344 lbs. and 8,785 lbs, including payload for Stage II.

An analysis of the weight empty estimate by groups is as follows:

(1) Warhead and Skirt

The warhead (6000 lbs.) including case and explosive is Government furnished, while the skirt (240 lbs.) is C.V.A.C. fabricated of .250 steel and .072 alclad.

(2) Body

The body is C.V.A.C. fabricated and consists of an oxygen and an alcohol tank of .072 alclad based upon preliminary stress computation and an aft or cowl section also of .072 alclad. Bulkheads, fittings, supporting structure, etc. were ratioed directly from the model MX-774 wherever possible.

(3) Fins

Estimated at 2.5 lb./sq.ft. for 60 sq.ft.

(4) Power Plant

Vendor furnished weights, compared with existing model MX-774 weights, were used for purchased items. C.V.A.C. supporting structure, hydrogen peroxide and helium tanks, plumbing, and miscellaneous were ratioed from the model MX-774.

(5) Equipment

Electronic weights are from vendor's specifications. Controls in part are based upon the MX-774. The warhead ejection mechanism and miscellaneous structure are C.V.A.C. estimated.

ANALYSIS
PREPARED BY
CHECKED BY
REVISED BY

CONSOLIDATED VULTEE AIRCRAFT CORPORATION

PAGE 55
REPORT NO ZF-48-3500
MODEL APPENDIX A
DATE 11-23-48

San Diego DIVISION

SECRET

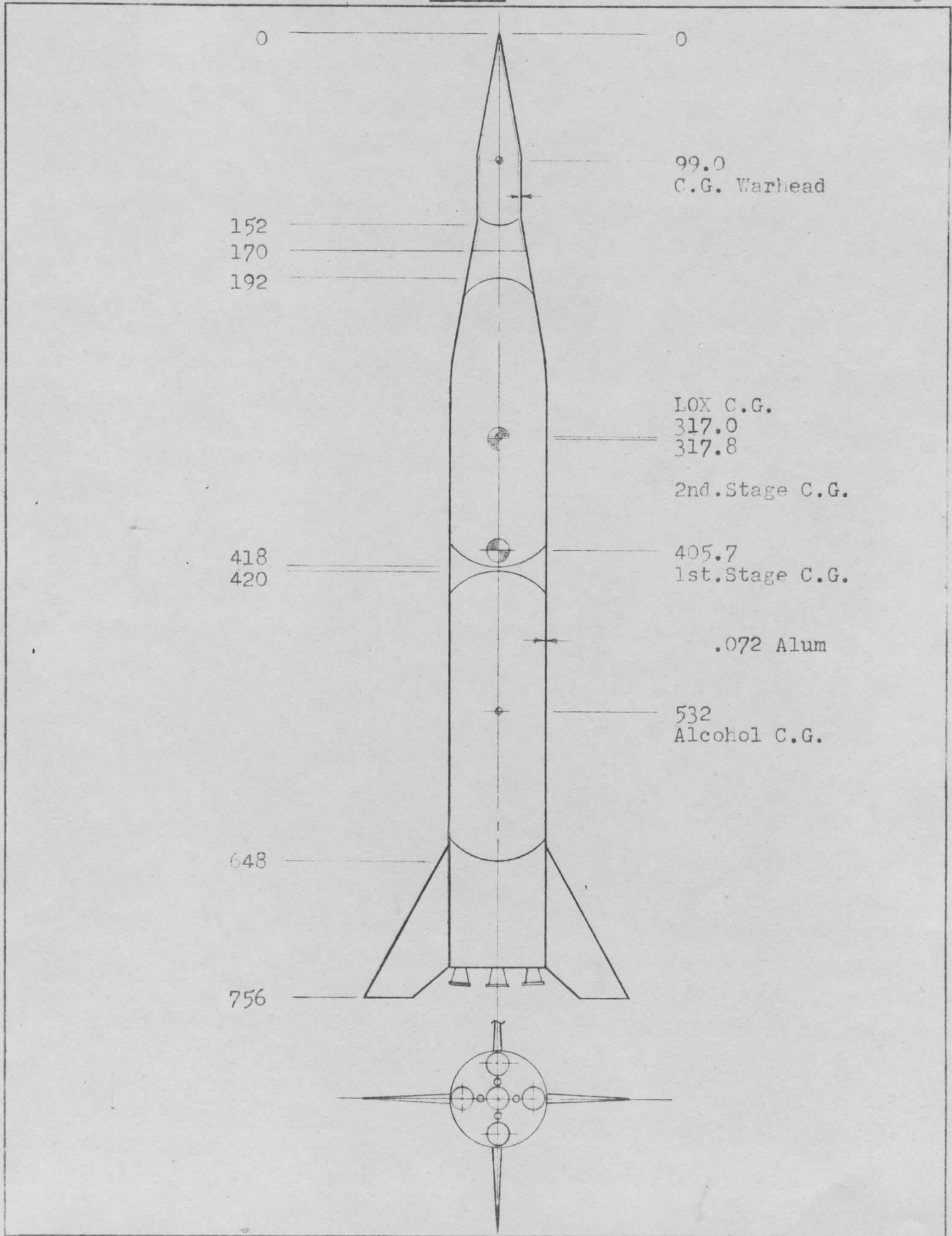

GO 241-1 VELLUM 357

SECRET

GROSS WEIGHT SUMMARY

(6000 lb Warhead, 1000 Mile Missile)

<u>Gross Weight</u>	<u>STAGE I</u>			<u>STAGE II</u>		
	<u>Weight</u>	<u>Arm</u>	<u>Moment</u>	<u>Weight</u>	<u>Arm</u>	<u>Moment</u>
	73484	405.7	29809337	16351	317.8	5196790
<u>Weight Empty</u>	(11344)	(338.6)	(3840773)	(8785)	(231.6)	(2034915)
Payload	6240	101.6	634080	6240	101.6	634080
Body	1374	479.2	658433	1129	432.1	487863
Fins (4)	150	717.0	107550	-	-	-
Power Plant	2997	691.7	2073040	1039	660.9	686654
Equipment	583	630.7	367670	377	600.3	226318
<u>Fuel</u>	(62140)	(417.9)	(25968564)	(7566)	(417.9)	(3161875)
Hydrogen Peroxide	1243	680	845240	151	680	102680
Liquid Oxygen	33832	317	10724744	4119	317	1305723
Alcohol	27065	532	14398580	3296	532	1753472

WRIGHT EMPTY
WEIGHT AND BALANCE
 (6000 lb. Warhead, 1000 Mile Missile)

ITEM	STAGE I		STAGE II	
	WEIGHT	MOMENT	WEIGHT	MOMENT
<u>WRIGHT EMPTY</u>				
<u>Payload</u>	11344 (6240)	338.6 (101.6)	8785 (6240)	231.6 (101.6)
Warhead	6000	594000	6000	594000
Skirt	240	40080	240	40080
<u>Body</u>	(1374)	(479.2)	(1129)	(432.1)
Forward Fuel Tank (Lox)	496	157232	496	157232
Bulkhead and Skin (Between Tanks)	95	39615	95	39615
Aft Fuel Tank (Alcohol)	438	233016	438	233016
Aft Structure At Engine Including Fin Atta chment	285	196650	40	26080
Lox Tunnel and Insulation	60	31920	60	31920
<u>Fins</u> (4)	(150)	(717)	(-)	(-)
<u>Power Plant</u>	(2997)	(691.7)	(1039)	(660.9)
<u>Motors and Propellent Valves</u>	(1225)	(717.6)	(457)	(718.7)
(4) 20000 lb. Thrust	768	550656	-	-
(1) 20000 lb. Thrust	192	137664	192	137664
(4) 2000 lb. Thrust (Including Propellent Valves and Swivel Motors)	165	120780	165	120780
(4) 20000 lb. Thrust Propellent Valves	80	56000	80	56000
(1) 20000 lb. Thrust Propellent Valves	20	14000	20	14000
<u>Pumps</u> (3)	(525)	(678.1)	(145)	(660.0)
(2) 80000 lb. Thrust	380	260300	-	-
(1) 28000 lb. Thrust	145	95700	145	95700

San Diego DIVISION
SECRET

ITEM	STAGE I		STAGE II	
	WEIGHT	ARM	WEIGHT	ARM
		MOMENT		MOMENT
<u>Mounts (2)</u>	(210)	(679.8)	(110)	(675.0)
30000 lb. Thrust	100	685	-	-
28000 lb. Thrust	110	675	110	675
		68500		74250
		74250		74250
<u>Valves and Regulators</u>	(160)	(685.0)	(40)	(685.0)
		(109600)		(27400)
28000 lb. Thrust	40	685	40	685
80000 lb. Thrust	120	685	-	-
		27400		27400
		82200		-
<u>Lines and Fittings</u>	(365)	(670.0)	(135)	(664.1)
		(244550)		(89650)
28000 lb. Thrust	95	670	95	670
80000 lb. Thrust	270	670	40	650
		63650		63650
		180900		26000
<u>Pressure Supply</u>	(150)	(677.5)	(35)	(626.9)
		(101620)		(21940)
Heat Exchanger - Oxygen and Hydrogen Peroxide Pressure	12	670	12	670
Helium Tank - Alcohol Pressure	115	680	-	-
Helium Tank - Control Operation	13	660	13	660
Helium	10	680	10	532
		8040		8040
		78200		-
		8580		9580
		6800		5320
<u>Pump Propulsion System</u>	(132)	(681.2)	(32)	(685.0)
		(89920)		(21920)
(2) Hydrogen Peroxide Tank (Large)	100	680	-	-
(1) Hydrogen Peroxide Tank (Small)	32	685	32	685
		68000		21920
		21920		21920
<u>Residual Fuel</u>	(230)	(650.0)	(85)	(644.1)
		(149500)		(54750)
28000 lb. Thrust	60	650	60	650
80000 lb. Thrust	170	650	25	630
		39000		39000
		110500		15750

ITEM	STAGE I		STAGE II	
	<u>WEIGHT</u>	<u>ARM</u>	<u>WEIGHT</u>	<u>ARM</u>
<u>FIXED EQUIPMENT</u>				
<u>Stabilization</u>				
(4) Amplifiers	(583)	(630.7)	(377)	(600.3)
(5) Gyros	(165)	(654)	(132)	(654)
(6) Valves	20		20	
(6) Response Units	22		22	
Inverter	36		18	
Batteries	30		15	
Miscellaneous (Wire, Brackets, Etc.)	12		12	
	30		30	
	15		15	
				(226318)
				(86328)
<u>Command - Doppler - Range</u>	(70)	(654)	(70)	(654)
Command	27		27	
Range & Doppler	25		25	
Batteries	18		18	
<u>Phase Comparator Transmitter</u>	(65)	(654)	(65)	(654)
Unit	50		50	
Batteries	15		15	
				(42510)
<u>Engine Swivel Controls</u>	(193)	(696.2)	(40)	(720.0)
8000 lb. Thrust	40	720	40	720
80000 lb. Thrust	153	690	-	-
				28800
				105570
<u>Staging Controls</u>	(40)	(710)	(20)	(710)
Warhead Ejection	(50)	(174)	(50)	(174)
				(28800)
				(14200)
				(8700)
				(45780)
				(28800)

STRUCTURES

Loads Analyses

An analysis will be shown here of the loads on the missile. Loads will be shown for maneuver condition only. Gust condition has been investigated for the 3000 lb warhead missile and found to be not critical. Computations and loads for gust condition are shown in appendix B of this report.

Loads are shown for the most critical portion of the flight path from which the most critical point is selected.

Shear and bending moment tables are presented for the critical condition. Stresses and margins of safety are shown for obviously critical sections of the missile body to indicate the feasibility of the structural design.

Maneuver Condition

The 6000 lb warhead, 1000 mile, rocket type missile is symmetrical about the longitudinal axis and therefore equally stable in pitch and yaw. Control is accomplished by means of eight pivoted, rocket type motors each of which may be deflected angularly by a definite amount. Four of these motors develop 2000 lbs. thrust per motor and four develop 20,000 lbs. thrust per motor. A schedule of operation of these motors for control is shown on page 41.

For the purpose of computing maneuvering loads, the effect of the 2000 lbs. thrust motors is small and will be neglected. From the above referenced schedule of operation, it will be noted that the maximum deflection of the 20,000 lb thrust motors for yaw and pitch control is 2.00 degrees. The full deflection of both pairs of motors will be assumed for the critical maneuvering condition. Hence, the resultant loads on the missile will be those computed for maximum angle of attack in either pitch or yaw times the factor 1.414.

The maximum angle of attack of the missile at any point on the flight path will be taken as $2 \times \alpha_{trim}$. This assumption is conservative since $2 \times \alpha_{trim}$ is the limiting value of angle of attack for instantaneous deflection of the motors neglecting dampening forces on the missile as it oscillates in its flight path. Since the idealized condition never exists the angle of attack will always be a value somewhat smaller than that used for computing the maneuvering loads.

The maneuver loads, therefore, are given by the following expression:

$$\text{Load} = \frac{\partial C_N}{\partial \alpha} \times 2\alpha_{trim} \times 1.414 \times q \times S$$

ANALYSIS
PREPARED BY
CHECKED BY
REVISED BY

CONSOLIDATED VULTEE AIRCRAFT CORPORATION

San Diego DIVISION

SECRET

PAGE 61
REPORT NO ZP-48-35003
MODEL Appendix A
DATE NOV. 23, 1948

Loads are computed for the critical region of the flight path and tabulated on page 63. The critical condition is selected from this tabulation and tables of shear and bending moment are prepared which include the effects of the air loads, rocket loads and the inertia forces required for equilibrium.

To expedite the analysis the inertia loads used are those corresponding to the initial weight of the missile. As a result the shears and bending moments are slightly conservative since the loss of weight in the missile is near the cg while the air loads are greater toward the ends.

THRUST & MACH NUMBER
AGAINST ALTITUDE

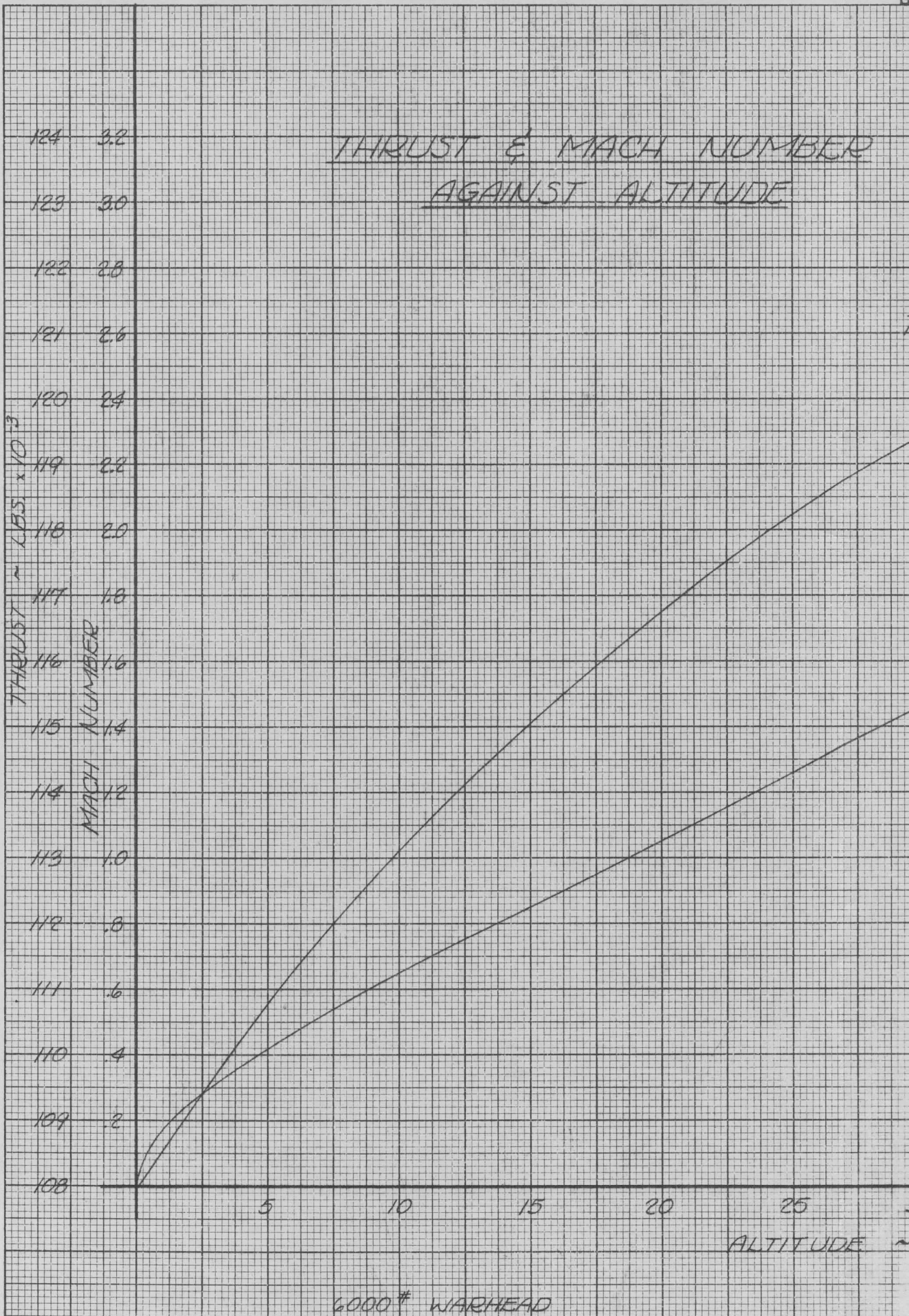

MADE IN U.S.A.
To X 10 to the 3d power lbs thrust
KEMPER & ESSER CO., N. Y. NO. 382-117

STR 6000 #

6000 # WARHEAD

SECRET

CLUST

MACH NO.

35 40 45 50 55 60 65 70
 $\times 10^{-3}$

SECRET

Nov. 23, 1948

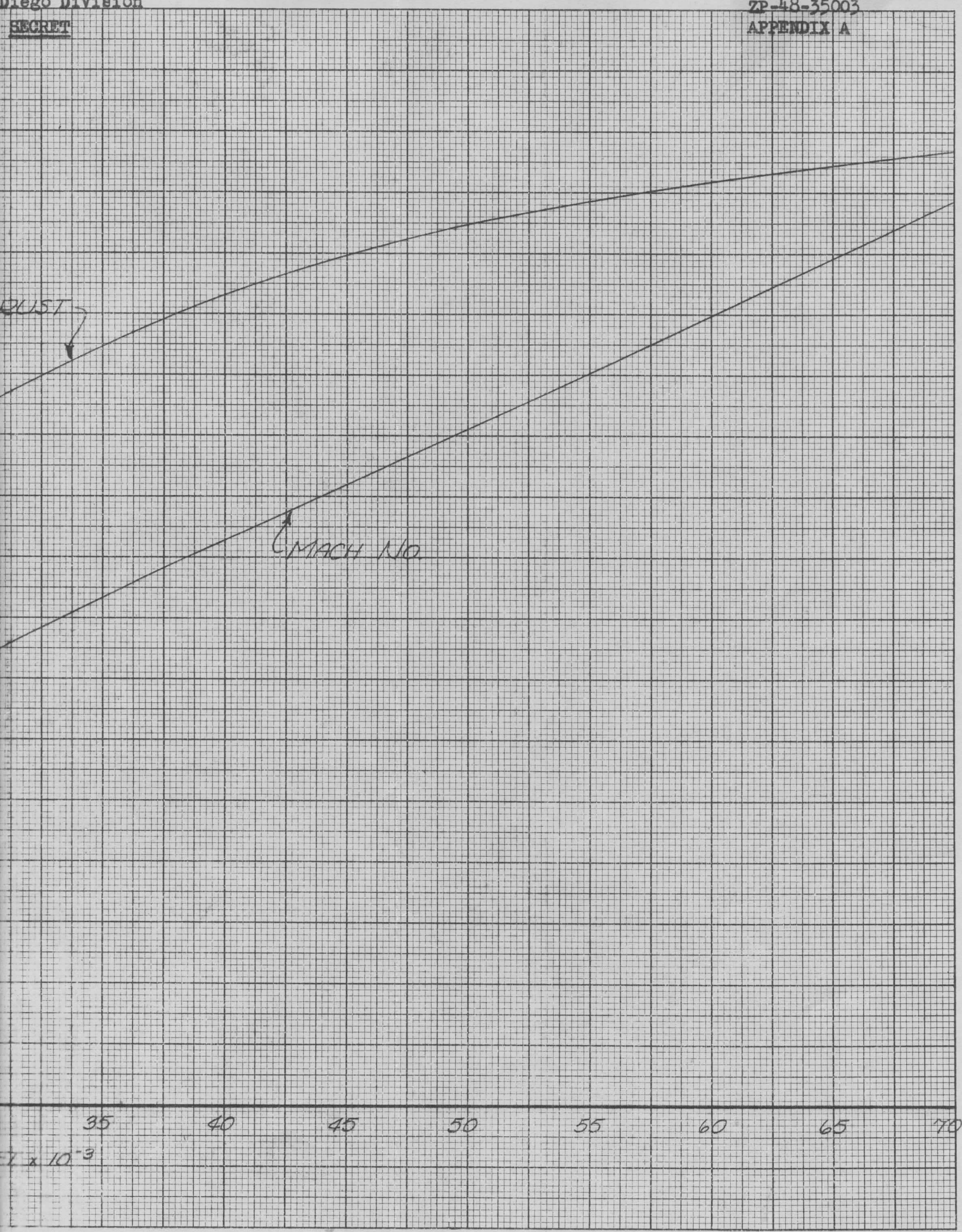

MANEUVERING LOADS

6000# WARHEAD

$q_s = 1481 \lambda M^2 S$ $L_d = \frac{\partial C_N}{\partial \alpha} \times 200 \alpha_{trim} \times q_s \times 1.414$ $\sin 2^\circ = .0349$

1	2	3	4	5	6	7	8	9	10	11	12
Alt.	M	λ	q_s	α_{trim}	Body	Fin	Body Load	Fin Load	Thrust	Thrust x sin 2°	Total Load
	Ref. #	Ref. #	$46651.5 \lambda \times M^2$	Ref. #	Ref. #	Ref. #	$2.828 \times 10^6 \times 4 \times 6 \times 4 \times 7$	$2.828 \times 10^6 \times 4 \times 7$	Ref. #	$.02467 \times 10$	$8 + 9 + 11$
5000	.42	.832	6848	9.8	.0406	.0245	7720	4650	110800	2734	9636
10000	.65	.6876	13552	5.2	.0403	.0251	8040	5000	113100	2791	10249
15000	.85	.5642	19017	3.5	.0401	.0266	7548	5007	115050	2839	9716
18000	.97	.4992	21912	3.0	.0401	.0282	7470	5250	116100	2865	9855
20000	1.05	.4593	23624	2.85	.0401	.0295	7650	5610	116700	2874	10381
22000	1.135	.4221	25364	2.8	.0402	.0295	8060	5920	117350	2895	11085
25000	1.26	.3709	27478	2.82	.0404	.0272	8850	5960	118200	2916	11894
30000	1.465	.2967	29703	3.2	.0410	.0234	11020	6300	119400	2946	14374
35000	1.665	.2351	30403	3.77	.0416	.0219	13500	7110	120450	2972	17638
40000	1.858	.1852	29824	4.42	.0424	.0208	15800	7760	121300	2993	20567
45000	2.04	.1458	28308	5.2	.0432	.0200	18000	8330	122000	3010	23320
50000	2.22	.1149	26414	6.0	.0441	.0192	19800	8600	122500	3023	25377
55000	2.405	.0905	24422	7.0	.0452	.0185	21800	8940	122850	3031	27709
60000	2.595	.0712	22369	8.2	.0465	.0176	24200	9150	123200	3040	30310
65000	2.783	.0561	20270	9.3	.0476	.0170	25400	9090	123400	3045	31445
70000	2.973	.04467	18450	10.7	.0488	.0164	27250	9160	123700	3052	33358
75000	3.158	.0352	16400	12.2	.0499	.0157	28200	8890	124000	3060	34030
80000	3.333	.0278	14400	13.3	.0506	.0151	27400	8180	124300	3070	32510

STANDARD AIR TABLES

MANEUVER CONDITION

BODY AIR LOAD DISTRIBUTION

(6000# Warhead)

M = 2.973 Alt. = 70,000'

Ld. = 27,250 at station 252

M = 6,867,000"#

<u>STA.</u>	<u>LD.</u>	<u>LD.xX</u>
0	100	0
40	1400	56,000
80	1300	104,000
120	100	12,000
160	2000	320,000
200	4500	900,000
240	4500	1,080,000
280	4000	1,120,000
320	4500	1,440,000
360	3000	1,080,000
400	1475	590,000
440	375	165,000

DEAD WEIGHT DISTRIBUTION
(6000# WARHEAD)

ITEM	W	X	WX	STATION														
				0	40	80	120	160	200	240	280	320	360					
Payload	6380		660120	100	900	1800	2450	997	133									
Body	1374		658433						55									
Fins	150	717	107550									85	90	100	100			
Power Plant	2977		2089580															
Fixed Equipment	583		371695					32.5	17.5									
Fuel	62000		25909120						3500			5100	5532	5728	6000			
TOTAL	73464	405.6	29796498	100	900	1800	2450	1029.5	3705.5	5185	5622	5828	6100					

ITEM	W	X	WX	STATION															
				400	440	480	520	560	600	640	680	720							
Payload																			
Body				400	440	480	520	560	600	640	680	720							
Fins	100			100	100	100	100	100	100	100	100	100	108	108	108	108	108	108	108
Power Plant													118	118	118	118	118	118	118
Fixed Equipment													11.2	11.2	11.2	11.2	11.2	11.2	11.2
Fuel	6000			6000	6480	5000	5000	5000	5000	5000	5000	5000	2780.4	2780.4	2780.4	2780.4	2780.4	2780.4	2780.4
TOTAL	6100			6100	6580	5100	5100	5100	5100	5100	5100	2994.4	2322.3	2347.3					

UNIT INERTIA SHEARS & MOMENTS
 (6000 Lb. Warhead)

1	2	3	4	5	6	7	8	9	10
Sta (χ)	Wt	S	ΔM	M	R	$\frac{WR}{g}$	S	ΔM	M
Ref. Pg 65	Σ ②	③ $\times \Delta \chi$	Σ ④	Ref. pg 62 for C.G.	② \times ⑥ x .002588	Σ ⑦	⑧ $\times \Delta \chi$	Σ ⑨	
0	100			0	405.6	91.6			0
40	900	100	4,000	4,000	365.6	743.2	91.6	3664	3664
80	1800	1,000	40,000	44,000	325.6	1323.8	834.8	33392	37056
120	2450	2,800	112,000	156,000	285.6	1580.5	2158.6	86344	123400
160	1030	5,250	210,000	366,000	245.6	571.4	3739.1	149564	272964
200	3706	6,280	251,200	617,200	205.6	1721.1	4310.5	172420	445384
240	5185	9,986	399,440	1,016,640	205.6	1721.1	6031.6	241264	686648
280	5622	15,171	606,840	1,623,480	165.6	1939.5	7971.1	318844	1005492
320	5828	20,793	831,720	2,455,200	125.6	1595.0	9566.1	382644	1388136
360	6100	26,621	1,064,840	3,530,040	85.6	1126.9	10693.	427720	1815856
400	6100	32,721	1,308,840	4,838,880	45.6	628.3	11321.3	452852	2268708
440	6580	38,821	1,552,840	6,391,720	5.6	77.2	11398.5	455940	2724648
480	5100	45,401	1,816,040	8,207,760	-34.4	-511.3	10887.2	435488	3160136
520	5100	50,501	2,020,040	10,227,800	-74.4	-857.1	10030.1	401204	3561340
560	5100	55,601	2,224,040	12,451,840	-114.4	-1317.9	8712.2	348488	3909828
600	5100	60,701	2,428,040	14,879,880	-154.4	-1778.7	6933.5	277340	4187168
640	2994	65,801	2,632,040	17,511,920	-194.4	-2239.5	4694.0	187760	4374928
680	2322	68,795	2,751,800	20,263,720	-234.4	-1585.2	3108.8	124352	4499280
720	2347	71,117	2,844,680	23,108,400	-274.4	-1439.2	1669.6	66784	4566064
		73,464			-314.4	-1666.8	0		

$M/S = 314.6$ (720-314.6 = 405.4)

$M = I\ddot{\alpha}$ for $\ddot{\alpha} = 1$

$I = M = \frac{4,566,064}{12} = 380,505$ Slug-ft²

SECRET

MANEUVER CONDITION--SHEARS & MOMENTS--(6000# WARHEAD)
 M = 2.973 Alt. 70,000 Ft.

1 Sta. (x)	Air Load				5 M Σ ④	6 S - .5788 x Col ③, pg 66	7 M - .5788 x Col ⑤, pg 66	8 S .02165 x Col ⑧, pg 66	9 M .02165 x Col ⑩, pg 66	10 S ⑤ + ⑥ + ⑧	11 M ⑤ + ⑦ + ⑨	TOTAL
	2 Ld Ref. Pg 64	3 S Σ ②	4 M ③ x Δx									
0	100	100	4000	0	0	0	0	0	0	0	0	0
40	1400	1500	60000	4000	58	2315	2	79	44	1764	1764	1764
80	1300	2800	112000	64000	580	25500	18	802	938	39302	39302	39302
120	100	2900	116000	176000	1621	90290	47	2672	1226	88382	88382	88382
160	2000	4900	196000	292000	3039	211800	81	5910	58	86110	86110	86110
200	4500	9400	376000	488000	3635	357200	93	9643	1358	140443	140443	140443
240	4500	13900	556000	864000	5780	588400	131	14870	3751	290470	290470	290470
280	4000	17900	716000	1420000	8781	939700	173	21770	5292	502070	502070	502070
320	4500	22400	896000	2136000	12035	1421100	207	30050	6072	744950	744950	744950
360	3000	25400	1016000	3032000	15408	2043200	232	39310	7224	1028110	1028110	1028110
400	1475	25400	1016000	4048000	18939	2800700	245	49120	6706	1296420	1296420	1296420
440	375	26875	1075000	5123000	22470	3699500	247	58990	4652	1482490	1482490	1482490
480	0	27250	1090000	6213000	26278	4750700	236	68420	1208	1530720	1530720	1530720
520	0	27250	1090000	7303000	29230	5919900	217	77100	1763	1460200	1460200	1460200
560	0	27250	1090000	8393000	32182	7207100	189	84650	4743	1270550	1270550	1270550
600	0	27250	1090000	9483000	35134	8612500	150	90650	7734	961150	961150	961150
640	0	27250	1090000	10573000	38086	10135900	102	94720	10734	531820	531820	531820
680	0	27250	1090000	11663000	39819	11728600	67	97410	12502	31810	31810	31810
700	-3052	24198	545000	12208000	41163	12551900	36	98130	13877	-245770	-245770	-245770
709	18320	42518	217782	12425782	41163	12922400	36	98454	16929	-398164	-398164	-398164
720	0	42518	850360	13276142	41163	13375000	36	98860	1391	0	0	0
		42518		-42521								

SECRET

STRUCTURES

(6000 lb Warhead, 1000 mile Missile)

Propulsion and Operation Tanks

This section analyzes the propulsion and operation tanks used in the 6000 lb warhead rocket type missile.

The various tanks used, their general purpose and manner of loading are as follows:

HELIUM TANKS: These tanks serve to pressurize the fuel tank and to operate engine control valves. They are analyzed for internal pressure loads only.

HYDROGEN PEROXIDE TANKS: These tanks operate the pump turbines and are analyzed for internal pressure loads only.

ALCOHOL TANK: This fuel tank forms the body structure of the missile and is analyzed for body bending, axial and shear loads as well as for internal pressure loads.

OXYGEN TANK: This oxidizer fuel tank forms the body structure also and is analyzed for body bending, axial and shear loads as well as for internal pressure loads.

One or more of the above type tanks are utilized as explained below.

Two helium tanks are used. The tank supplying the pressurization for the fuel tank separates from the missile with the booster stage. It consists of two spherical ends of radius 10 inches connected by a 15 inch flat cylinder.

Working pressure	= 2,000 psi	
Yield pressure	= 1.25 (2,000) = 2,500 psi	
Radius, R	= 10 inches	
Length, l	= 15 inches	
Thickness of spherical ends, t	= 0.125 inches	Allow an 0.80 reduction factor for thinning out of material due to forming
Thickness of cylinder, t	= 0.250 inches	

Material = 4130 steel sheet
 $F_{tu} = 150,000$ psi
 $F_{ty} = 135,000$ psi

f_{ty} (spherical ends) = $\frac{2500 (10)}{2 (.125)(.8)} = 125,000$ psi
M.S. = $\frac{135,000}{125,000} - 1 = \underline{+.08}$

f_{ty} (cylinder) = $\frac{2,500 (10)}{.25} = 100,000$ psi
M.S. = $\frac{135,000}{100,000} - 1 = \underline{+.35}$

The spherical ends and 15 inch cylinder are welded together with butt joints as shown in the sketch on page 123 OF APP. C.

Thickness of doublers, $t = 0.125$ inches

F_{ty} at weld = 60,000 psi

$$f_{ty} = \frac{2,500 (10)}{2 (.125 + .125)} = 50,000 \text{ psi}$$

$$\text{M.S.} = \frac{60,000}{50,000} - 1 = \underline{+.20}$$

The second helium tank operates the engine controls. It is a spherical tank of radius 5 inches.

Working pressure = 2,000 psi
Yield pressure = 1.25 (2,000) = 2,500 psi
Radius, R = 5 inches
Thickness, $t = 0.062$ inches
Thickness of doublers, $t = 0.062$ inches

Material = 4130 steel sheet

$$\text{Least M.S. (ref. page 124) OF APP. C} = \underline{+.06}$$

Three hydrogen peroxide tanks are used. The first two tanks are of the same shape and are dropped with the booster stage. The tanks are formed by two spherical ends of radius 10 inches connected by an 18 inch cylinder.

Working pressure = 450 psi
Yield pressure = 1.25 (450) = 563 psi
Radius, R = 10 inches
Length, $l = 18$ inches

Thickness of spherical ends, $t = 0.102$ inches
Thickness of cylinder, $t = 0.250$ inches

Allow an .80 reduction factor for thinning out of material due to forming.

Material = 61 ST, $F_{ty} = 35,000$ psi

f_{ty} (spherical ends) = $\frac{563(10)}{2(.102)(.8)} = 34,600$ psi

M.S. = $\frac{35,000}{34,600} - 1 = \underline{+.01}$

f_{ty} (cylinder) = $\frac{563(10)}{.25} = 22,200$ psi

M.S. = $\frac{35,000}{22,200} - 1 = \underline{+.57}$

The spherical ends and 18 inch cylinder are welded together with butt joints as shown in the sketch on page 123 OF APP. C.

Thickness of doublers, t = 0.250 inches

F_{ty} at weld = 9,000 psi

f_{ty} = $\frac{563(10)}{2(.102 + .250)} = 8,000$ psi

M.S. = $\frac{9,000}{8,000} - 1 = \underline{+.12}$

The third hydrogen peroxide tank consists of two spherical ends of radius 10 inches connected by a 4 inch cylinder.

Working pressure = 450 psi
Yield pressure = 1.25 (450) = 563 psi
Radius, R = 10 inches
Length, l = 4 inches
Thickness of spherical ends, t = 0.102 inches
Thickness of cylinder, t = 0.250 inches
Thickness of doublers, t = 0.250 inches

Material = 61 ST, $F_{ty} = 35,000$ psi

Least M.S. (ref. above calculations) = +.01

The alcohol tank is critical at body station 629. The section will be checked for the maximum body bending moment and axial load, and internal pressure existing at 70,000 ft altitude.

$$\text{B.M.} = 1,530,720 \text{ in.lb. (Ref. page 67)}$$

The axial load will be computed as follows:

$$\text{Thrust} = 123,700 \text{ lb.}$$

$$\text{Weight of missile at 70,000 ft altitude} = 34,000 \text{ lb.}$$

$$\text{Drag inertia load factor} = \frac{123,700}{34,000} = 3.64$$

$$\begin{aligned} \text{Weight of inertia items aft of station 629 not including fuel} \\ = 4,004 \text{ lb.} \end{aligned}$$

$$\text{Weight of hydrogen peroxide aft of station 629} = 453 \text{ lb.}$$

$$\text{Weight of alcohol in aft tank} = 9,883 \text{ lb.}$$

$$\begin{aligned} \text{Therefore, total weight at station 629} &= 34,000 - 4,004 - 453 - \\ & 9,883 = 19,660 \text{ lb.} \end{aligned}$$

$$\text{Then, axial load at station 629} = 3.64 (19,660) = 71,500 \text{ lb.}$$

$$\text{Internal pressure} = 20 \text{ psi}$$

The critical section is an 0.072 in. thick circular cylinder of radius 37.98 inches. The material is 61 ST sheet, $F_{ty} = 35,000 \text{ psi}$.

$$\begin{aligned} f_c &= \frac{\text{B. M.}}{\pi R^2 t} + \frac{P}{A} \\ &= \frac{1,530,720}{\pi (37.98)^2 (.072)} + \frac{71,500}{2 (\pi) (37.98) (.072)} \\ &= 8,860 \text{ psi} \end{aligned}$$

$$\begin{aligned} f_t &= \frac{20(37.98)}{2(.072)} \\ \text{(due to internal pressure)} &= \\ &= 5,280 \text{ psi} \end{aligned}$$

$$\text{Resulting } f_c = 8,860 - 5,280$$

$$= 3,580 \text{ psi}$$

$$F_c = 3,600 \text{ psi (Ref. page 127 OF APP. C)}$$

$$\text{M.S.} = \frac{3,600}{3,580} - 1 = \underline{+.005}$$

The tank is formed by use of 61 ST doublers butt-welded together as shown in the sketch on page 123 OF APP. C.

$$\text{Static internal pressure} = 60 \text{ psi}$$

$$\text{Thickness of tank cylinder, } t = 0.072 \text{ inches}$$

$$\text{Thickness of doublers at weld, } t = 0.188 \text{ inches}$$

$$\text{Least M. S. (Ref. page 127) = } \underline{+.025}$$

APP. C

The oxygen tank will be analyzed at body station 248. The section will be checked for the existing body bending moment and axial load and internal pressure.

$$\text{B. M.} = 342,470 \text{ in. lb. (Ref. page 67).}$$

The axial load will be computed as follows:

$$\text{Thrust} = 123,700 \text{ lb.}$$

$$\text{Weight of missile at 70,000 ft altitude} = 34,000 \text{ lb.}$$

$$\text{Drag inertia load factor} = \frac{123,700}{34,000} = 3.64$$

$$\begin{aligned} \text{Weight of inertia items aft of station 248 not including fuel} \\ = 4,894 \text{ lb.} \end{aligned}$$

$$\text{Weight of hydrogen peroxide aft of station 248} = 453 \text{ lb.}$$

$$\text{Weight of alcohol in aft tank} = 9,883 \text{ lb.}$$

$$\text{Weight of oxygen in forward tank} = 12,340 \text{ lb.}$$

$$\begin{aligned} \text{Therefore, total weight at station 248} &= 34,000 - 4,894 - \\ &453 - 9,883 - 12,340 = 6,430 \text{ lb.} \end{aligned}$$

SECRET

Then, axial load at station 248 = $3.64 (6,430) = 23,400$ lb.

Internal pressure = 20 psi

The critical section is an 0.072 inch thick circular cylinder of radius 34 inches. The material is 61 ST sheet, $F_{ty} = 35,000$ psi.

$$\begin{aligned} f_c &= \frac{\text{B.M.}}{\pi R^2 t} + \frac{P}{A} \\ &= \frac{342,470}{\pi (34)^2 (.072)} - \frac{23,400}{2(\pi)(34)(.072)} \\ &= 2,840 \text{ psi} \end{aligned}$$

$$\begin{aligned} f_t &= \frac{20(34)}{2(.072)} \\ (\text{due to internal pressure}) &= 4,720 \text{ psi} \end{aligned}$$

$$\begin{aligned} \text{Resulting } f_t &= 4,720 - 2,840 \\ &= 1,880 \text{ psi} \end{aligned}$$

Therefore, M. S. is ample.

The tank is formed by use of 61 ST doublers butt-welded together as shown in the sketch on page 123 OF APP. C.

Static internal pressure = 60 psi

Thickness of tank cylinder, $t = 0.072$ inches

Thickness of doublers at weld, $t = 0.138$ inches

Least M. S. (Ref. page 127) = 1.025
APP. C

PERFORMANCE ANALYSIS

(6000 LB. WARHEAD, 1000 MILE MISSILE)

The 6000 lb. warhead, 1000 mile missile is powered by five 20,000 pound thrust rocket motors and four 2000 pound thrust rocket motors. The missile operates in two stages and is unique in the fact that the same fuel tanks are used in both stages, thus saving much airframe weight. At the end of the booster stage, the four large outside rocket motors are dropped along with related accessories and the entire fin and an appreciable amount of skin and structure. The missile then continues on to the end of burning, powered by one 20,000 pound thrust rocket motor and four 2,000 pound thrust rocket motors.

Various distributions of fuel between the first and second stages of the missile and various types of flight paths were investigated to ascertain as closely as possible an optimum range. Using optimum conditions, thus obtained, the performance of the booster stage was computed by means of a step by step integration. A programmed attitude of the missile was assumed, which would closely approximate a zero angle of attack path.

The step by step calculations were based on the following relationship which is based on the assumption of a zero angle of attack flight path.

$$\frac{dV}{dt} = g \left[-\sin \gamma + \frac{T-D}{W} \right]$$

$$\frac{d\gamma}{dt} = - \frac{g \cos \gamma}{V}$$

$$\frac{dh}{dt} = V \sin \gamma$$

$$\frac{dR_g}{dt} = V \cos \gamma$$

where T = thrust for a given altitude
D = drag = $q S C_D$
W = weight at a given time
 γ = flight path angle with respect to the horizontal plane at launching site.
V = velocity at a given time
h = altitude at a given time
R_g = range at a given time
t = time

PERFORMANCE ANALYSIS (Cont'd)

(6000 LB. WARHEAD, 1000 MILE MISSILE)

The drag analysis was based on the methods outlined in reference 2 and the variation of drag coefficient with Mach number and altitude is presented on page .

The step by step calculations were carried out to the end of burning of the booster stage at which time the drag becomes very small. For the final stage of operation the following "no drag" method was used to obtain the conditions at the end of burning. The slight error introduced by neglecting drag is more than compensated for by neglecting the reduction in gravitational acceleration with altitude.

Assuming a constant attitude angle θ during the final stage we have:

$$V_x = V_1 \cos \gamma_1 + (I_2 g \log_e m_2) \cos \theta$$

$$V_z = V_1 \sin \gamma_1 + (I_2 g \log_e m_2) \sin \theta - g t_2$$

$$V = \sqrt{V_x^2 + V_z^2} = \text{Velocity along flight path at fuel shut-off}$$

$$S_x = S_{1x} + V_1 t_2 \cos \gamma_1 + \frac{I_2^2 g}{a_2} \left(1 - \frac{1}{m_2} - \frac{\log m_2}{m_2} \right) \cos \theta$$

$$S_z = S_{1z} + V_1 t_2 \sin \gamma_1 + \frac{I_2^2 g}{a_2} \left(1 - \frac{1}{m_2} - \frac{\log m_2}{m_2} \right) \sin \theta - \frac{1}{2} g t_2^2$$

V_1 = Velocity at end of booster stage

γ_1 = Flight path angle at end of booster stage

$$\gamma_1 = \text{TAN}^{-1} \frac{V_z}{V_x} = \text{Flight path angle at fuel shut-off}$$

correction for curvature of the earth

$$\Delta \gamma = \text{TAN}^{-1} \frac{S_x}{r_0}$$

$$\gamma = \gamma_F + \Delta \gamma \text{ Corr. flight path angle at end of burning}$$

$$\theta = \text{missile attitude}$$

PERFORMANCE ANALYSIS (Cont'd)

(6000 LB. WARHEAD, 1000 MILE MISSILE)

V_x and V_z = horizontal and vertical components at fuel shut-off

S_x and S_z = horizontal and vertical components of distance traveled at fuel shut-off.

The equation for calculating elliptical orbits which includes the curvature of the earth is:

$$\theta_{R_2} = \cos^{-1} \frac{B}{\sqrt{P^2 + Q^2}} + \tan^{-1} \frac{P}{Q}$$

where

$$A = \frac{r_1 V^2}{4}$$

$$B = \frac{1}{A} - \cos^2 \gamma \left(\frac{r_1}{r_0} \right)$$

$$Q = \frac{1}{A} - \cos^2 \gamma$$

$$P = \frac{1}{2} \sin 2\gamma$$

$$r_1 = r_0 + S_z$$

$$\gamma = g_0 r_0^2$$

r_0 = radius of earth = 3963 miles

Thus having θ_{R_2} the total range of the missile becomes

$$R = \frac{\theta_{R_2}}{57.3} 3963 + S_x$$

PERFORMANCE ANALYSIS (Cont'd)

(6000 LB. WARHEAD, 1000 MILE MISSILE)

A summary of the performance based on the above analysis for the 6000 pound warhead, 1000 mile missile is presented below.

STAGING CONDITIONS

	<u>Booster Stage (I)</u>	<u>Final Stage (II)</u>
Weight Full	73,484 lbs.	17,470 lbs.
Weight Empty	11,344 lbs.	8,785 lbs.
Weight of Fuel (total)	62,140 lbs.	8,685 lbs.
Thrust at S.L.	108,000 lbs.*	28,000 lbs.*
Specific Impulse at S.L.	210 sec.	210 sec.
Fuel Consumption	514 #/sec.	133.3 #/sec.
Mass Ratio	3.66***	1.98
Initial Acceleration	1.462	1.864**
Time of Burning	104.0 sec.	65.1 sec.

PERFORMANCE SUMMARY

	<u>Performance at End of Booster Stage</u>	<u>Performance at End of Final Stage</u>
Velocity along Flight Path	6,556 ft/sec.	10,666 ft/sec.
S _z - Altitude	28.5 miles	84.9 miles
S _x - Range	26.9 miles	112.9 miles
- Flight Path Angle	36.3°	33.22°
- Missile Attitude	36.3°	45°

Maximum Altitude = 255 miles

Total Range = 932 miles

* See pages 80 and 81 for variation with altitude thrust

** Corrected for thrust at altitude.

*** Mass ratio booster stage (I) = $\frac{\text{weight full}}{\text{weight empty} + \text{Stage II fuel}}$

PERFORMANCE ANALYSIS (Cont'd)

(6000 LB. WARHEAD, 1000 MILE MISSILE)

The above results are using existing rockets, as designed by Reaction Motors, Inc. With a slight change of design of the exit, the thrust of these rockets may be increased over the operating altitude region by approximately 5%. This would increase the range to 1025 miles. An additional increase in range might be obtained by varying the distribution of fuel between booster and final stages (varying the time of separation). It is possible also that a better performance can be shown by dropping one pair of 20,000 lb. engines before the end of the booster stage. This could be accomplished without undue mechanical complication. Lack of time prevented a more thorough analysis of these features at this time.

ROCKET TYPE MISSILE

(6000 LB. WARHEAD ~ 1000 MI.)

DRAG COEFFICIENT AS A FUNCTION OF MACH NUMBER

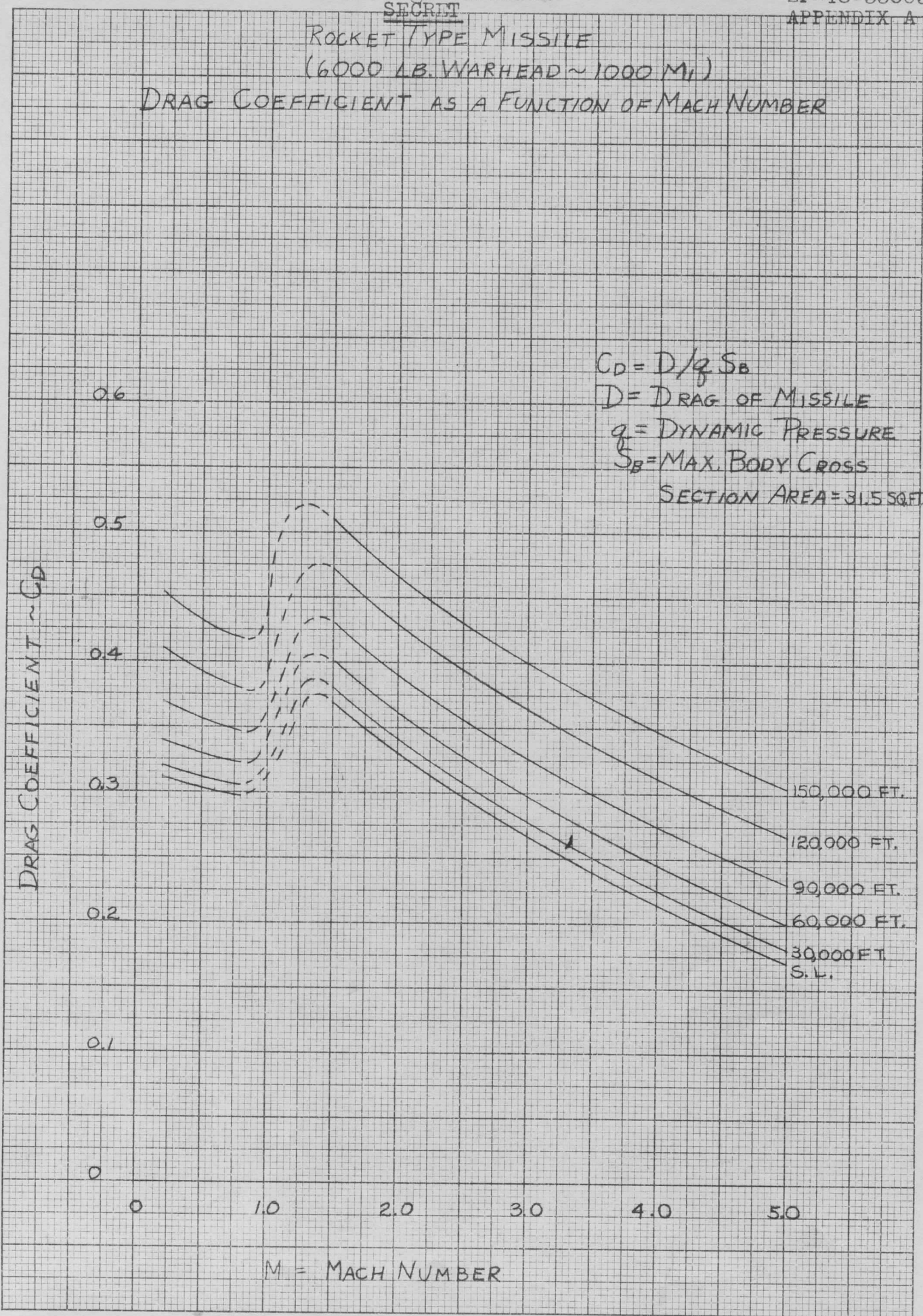

$C_D = D/q S_B$

D = DRAG OF MISSILE

q = DYNAMIC PRESSURE

S_B = MAX. BODY CROSS

SECTION AREA = 31.5 SQ. FT.

DRAG COEFFICIENT ~ C_D

M = MACH NUMBER

NO. 320-11 10 x 10 to the part inch, 2 1/2 lines secured.

MADE IN U.S.A.
Engraving, 1 x 10 in.

KENNEL & ESSER CO.

REF 6000

SECRET

ROCKET TYPE MISSILE

ESTIMATED VARIATION OF THRUST WITH ALTITUDE
 FOR FOUR 2000 LB. THRUST ROCKETS

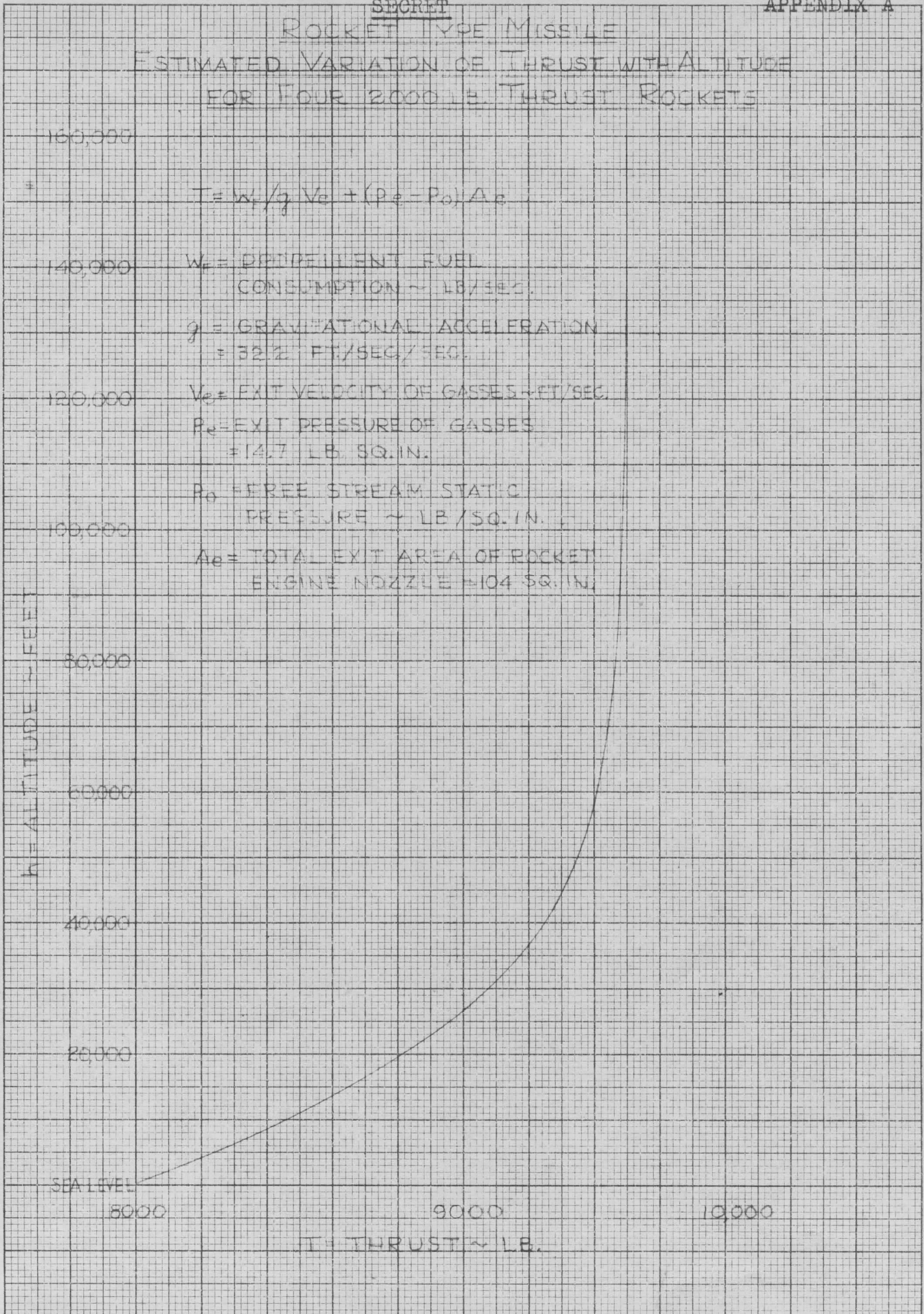

NO. 320-11 10 x 10 to the inch, 2 1/2 inch lines spaced.

ENGINEERING 10 x 10 in.

KENNEL & ESSER CO.

PERF 6000

SECRET

Nov. 23, 1948

SECRET

ROCKET TYPE MISSILE

ESTIMATED VARIATION OF THRUST WITH ALTITUDE
FOR ONE - 20000 LB. THRUST ROCKET

$$T = (w_F/g) V_e + (p_e - p_o) A_e$$

g = GRAVITATIONAL ACCELERATION = 32.2 FT/SEC²

w_F = PROPELLENT FUEL CONSUMPTION ~ LB/SEC.

V_e = EXIT VELOCITY OF GASES ~ FT/SEC.

p_e = EXIT PRESSURE OF GASES = 14.7 LB./SQ. IN.

p_o = FREE STREAM STATIC PRESSURE ~ LB./SQ. IN.

A_e = TOTAL EXIT AREA OF ROCKET ENGINE

NOZZLE = 201.5 SQ. IN.

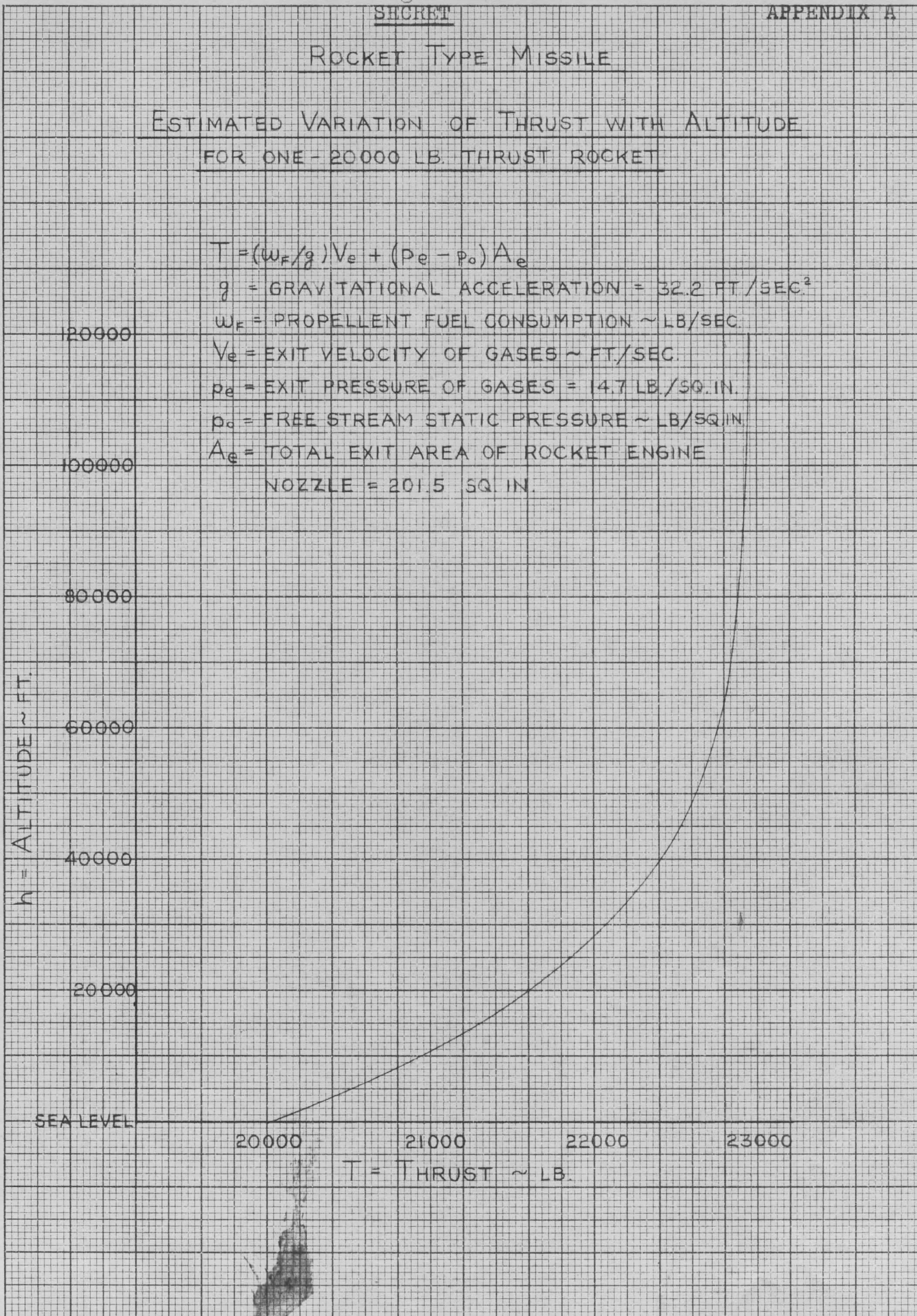

No. 322-11. 10 x 10 to the first inch, 2 1/2 inches accurate.
 Engraving 7 x 10 in.
 MADE IN U.S.A.

KENNEL & ESSER CO.

PERF 6000

SECRET

Nov. 23, 1948

ANALYSIS
PREPARED BY
CHECKED BY
REVISED BY

CONSOLIDATED VULTEE AIRCRAFT CORPORATION

SAN DIEGO DIVISION
SECRET

PAGE 82
REPORT NO ZP-48-35003
MODEL APPENDIX B
DATE Nov. 23, 194

APPENDIX B

GUIDANCE AND CONTROL

GUIDANCE FOR A 1,000 MILE MX-774 TYPE MISSILE

The greater portion of the guidance development work necessary for a 1,000 mile tactical, projectile-type missile has been performed by CVAC in the MX-774 and -770 activities. A stabilization system in which the attitude and course of the missile is controlled by swivelling the rocket motors has been fully developed and tested in the MX-774 test vehicle program. Numerous gimbal test stand firings have been made in which direct measurements of test vehicle attitude showed excellent stability and smooth response to command control of attitude. Two of these test vehicles have been fired at White Sands Proving Grounds; both firings were marked by completely stable flight of the vehicles. The more recent of these firings involved all of the most critical flight conditions - from the stabilization standpoint - encountered by a projectile-type missile; (1) the slow flight speed at and immediately following takeoff, (2) the transonic speed region and (3) the maximum dynamic pressure region.

The Radio Phase-Comparison Precision Tracking System developed under the original provisions of the MX-774 project was ground and flight tested thoroughly and the major problems presented by this radio technique were resolved. The tracking system obtains its elevation and azimuth angle information and range data in terms of radio phase angle measurements. Range is measured by transmitting a set of modulation frequencies to the missile, which retransmits them to the ground station. The relative phases of the outgoing and incoming signals are measured by means of phase comparators. The phase shift obtained at the lowest frequency in the set of modulation frequencies determines the approximate range, and at the successively higher frequencies, the determination becomes more precise using a system of decaded measurements.

Figure 3 is a diagram of the test system set up for flight tests with a C-46 aircraft.

Figure 4 shows a photograph of the test system combined receiver, phase-comparator and servo-computer unit. Angular measurements are given as shaft positions and velocities may be determined from rotational speed of the same shafts. A complete discussion of the development of the phase-comparison test component assemblies and an analysis of the test results is reported in Phase Comparison Angle Tracking System, CVAC Report No. ZN-6002-017, Ref. 3.

Angular measurements are made by measuring the relative phases of the carrier and one of the range modulation frequencies retransmitted from the missile as described above to antennas on the ground. These antennas are located on two baselines at right angles to each other, as shown in Figure 2, and are used in pairs. The coarsest angular measurements are made by comparing phases of modulation signals received on antennas separated less than a half wavelength at the modulation frequency. Successively more precise measurements are made by comparing signals received on antennas separated by larger numbers of wavelengths. The finest measurements are

made at the carrier frequency received on antennas separated several thousand wavelengths.

An analysis of phase comparison range measurement methods is reported in "CVAC Precision Range System MX-774", CVAC Report No. ZN-6002-019, (Ref. 4.) and the complementary treatment of phase comparison angular measurements is given in Ref. 3. The general proposal on application of phase comparison tracking to a complete guidance system for long range projectile-type missiles is reported in Guidance System for the MX-774 Missile, CVAC Report No. ZN-6002-007, (Ref. 5.).

The program for testing this technique was marked principally by the development of the phase comparators and heterodyning methods required to make precise determinations of phase angles between radio signals. The engineering development activity and the test results have been fully reported under the original MX-774 contract and appear in Ref. 3, Phase Comparison Angle Tracking System, CVAC Report ZN-6002-017.

The program performed with this equipment consisted of numerous laboratory, field and flight tests. Important component assemblies such as the phase comparators, filter units to separate modulation frequencies and computer-serve units were developed and tested in the laboratories. Field and flight tests were conducted to measure quantitatively the performance and accuracy of the entire system by checking a record of the phase system data with theodolite measurements. In the most significant test flight the system tracked a C-46 airplane from San Diego to Point Mugu, California, a distance of 137 miles with a net error of approximately 0.1 degree. This accuracy was in good agreement with calculated performance expected of the test system, and showed that greater accuracies may readily be attained by increasing the carrier frequency of the radio system, by separating the antennas further than was practical in the test system and by using narrow-beam antennas to eliminate ground reflections.

Essentially all the basic development work required to produce a tracking, guidance and stabilization system with the order of precision required by a projectile-type missile of 1,000 miles range has been accomplished in the programs outlined above. Producing a guidance system for a tactical MX-774 missile, then, involves principally an engineering project in which the stabilization equipment developed and proven in the MX-774 test vehicle program and the radio phase tracking units are combined with a conventional radio command system and are refined and integrated to form a complete guidance system capable of meeting the 1,000-mile range and accuracy specification.

Extensive studies of radio propagation in the troposphere and the ionosphere have been made in the MX-774 program to investigate the effect of these factors on the accuracy of phase comparison tracking. The studies have been reported in detail in three reports: "Ionosphere Refraction Error Estimate of Sighting Error and Increase of Phase Velocity" (CVAC Report No. DEVT-4018, Ref. 6.),

"Atmospheric Refraction Error Estimate of Sighting Error and Changes in Phase Velocity" (CVAC Report No. DEVF-4036, Ref. 7.) and "Atmospheric Errors and Their Effect Upon the Hitting Accuracy of the MX-774 Missile" (CVAC Report No. ZN-6002-011, Ref. 8.). The general conclusion of the radio propagation investigations is that, with the use of microwave frequencies, simple compensation of the computer section of a phase comparison tracking system will yield sufficient accuracy for a 1,000-mile missile. The accuracy requirements of longer range missiles, however, will require more complex compensation involving both seasonal and hourly variations in propagation factors.

Suitable microwave vacuum tubes of sufficient power capabilities are commercially available for the equipment at the present time. Also, the frequency stabilization techniques required to meet the accuracy needs have been proven in laboratory usage and they are immediately adaptable to the phase comparison tracking equipment. Antenna designs with proper beam and gain characteristics are readily available from radar developments.

This recapitulation of developments by CVAC and other contractors in the missile guidance and related fields indicates that the principal task in an engineering project for developing this guidance system is one of refining and fitting together existing components and techniques to achieve the requisite precision. Many of the usual problems in guidance design are avoided by the basic nature of the system; most of the units requiring stable operating conditions to effect precise measurements and computations are located on the ground where weight and complexity are secondary problems. Only the range and angle signal repeater (a radio repeater consisting of receiver and transmitter) and the radio command receiver are located in the missile, and these two equipment items may be combined to a considerable extent.

POSSIBLE IMPROVEMENTS IN ACCURACY OF THE PROPOSED SYSTEM

There are three basic limiting factors affecting the accuracy of phase comparison tracking methods. The first involves principally the maximum degree of resolution attainable in measuring radio phase angles, and the second factor is chiefly a function of the frequency stability attainable in the radio signal transmitters.

The above two limiting factors have been grouped together because their improvement is principally a problem in advanced laboratory development of equipment refinements. Closely allied with these factors are secondary considerations such as improved, faster responding computer mechanisms, more precise siting of the phase comparison antenna locations and baselines, and a more exact determination of the electrical center of directive antenna arrays than is presently possible.

An advanced developmental program directed to achieve the ultimate refinement of equipment proposed in the foregoing section capable of improving the accuracy of a 1000 mile missile (2,500 foot hit radius) by 30 to 50 percent. This improved relative accuracy can also be utilized to achieve the same limit of miss at ranges of 1,500 to 2,000 miles.

The third basic limiting factor in the accuracy of phase comparison equipment is the error introduced by refraction of radio waves and changes in radio propagation velocity in the various strata of the troposphere and the ionosphere. Presently available data on the earth's upper atmosphere permit only an order-of-magnitude calculation of their effects on sighting angle and relative phase measurements. (Studies of ionospheric and tropospheric effects have been reported by C.V.A.C. in Refs. 6, 7 and 8.)

Basic research into the composition, temperatures and pressures of the upper atmosphere and into the variations of electron densities in the ionosphere is required in order to minimize their effect on radio tracking data. Presumably, such research could be carried out as an adjunct to test programs in the development of a 1000 mile missile and in any program of extending its range to the 1500 to 2000 mile region. The results of such a research program would be applied to the calculation of tracking data corrections for insertion into the missile course computer. These corrections would compensate for the commonly ignored, relatively small variations in ionospheric and tropospheric effects which occur seasonally and hourly.

POSSIBLE IMPROVEMENTS IN ACCURACY OF THE PROPOSED SYSTEM (Cont'd)

The net result of utilizing second order corrections of this nature is estimated as effecting a reduction in guidance error of approximately 30 percent in addition to the reduction considered practicable by ultimate refinement of the tracking equipment itself. This improvement is considered sufficient to permit increasing missile range to perhaps 3,000 miles and maintaining the target miss to 2,500 feet, or extending range to 5,000 miles with a target miss of one mile.

REFERENCES

1. Calculation of Long Range Trajectories, C. T. Dozier and J. A. Cullen, CVAC Report No. ZN-6002-010.
2. Selection of Guidance System for MX-774 Missile, R. M. Barley, CVAC Report No. DEVF-4052.
3. Phase Comparison Angle Tracking System, R. C. Weaver, CVAC Report No. ZN-6002-017.
4. CVAC Precision Range System MX-774, R. V. Werner and R. A. Smith, CVAC Report No. ZN-6002-019.
5. Guidance System for the MX-774 Missile, J. W. Crooks, Jr., CVAC Report No. ZN-6002-007.
6. Ionosphere Refraction Error Estimate of Sighting Error and Increase in Phase Velocity, B. D. Abramis, CVAC Report No. DEVF-4018.
7. Atmospheric Refraction Error Estimate of Sighting Error and Changes in Phase Velocity, B. D. Abramis, CVAC Report No. DEVF-4036.
8. Atmospheric Refraction Errors and Their Effect Upon the Hitting Accuracy of the MX-774 Missile, B. D. Abramis, CVAC Report No. ZN-6002-011.

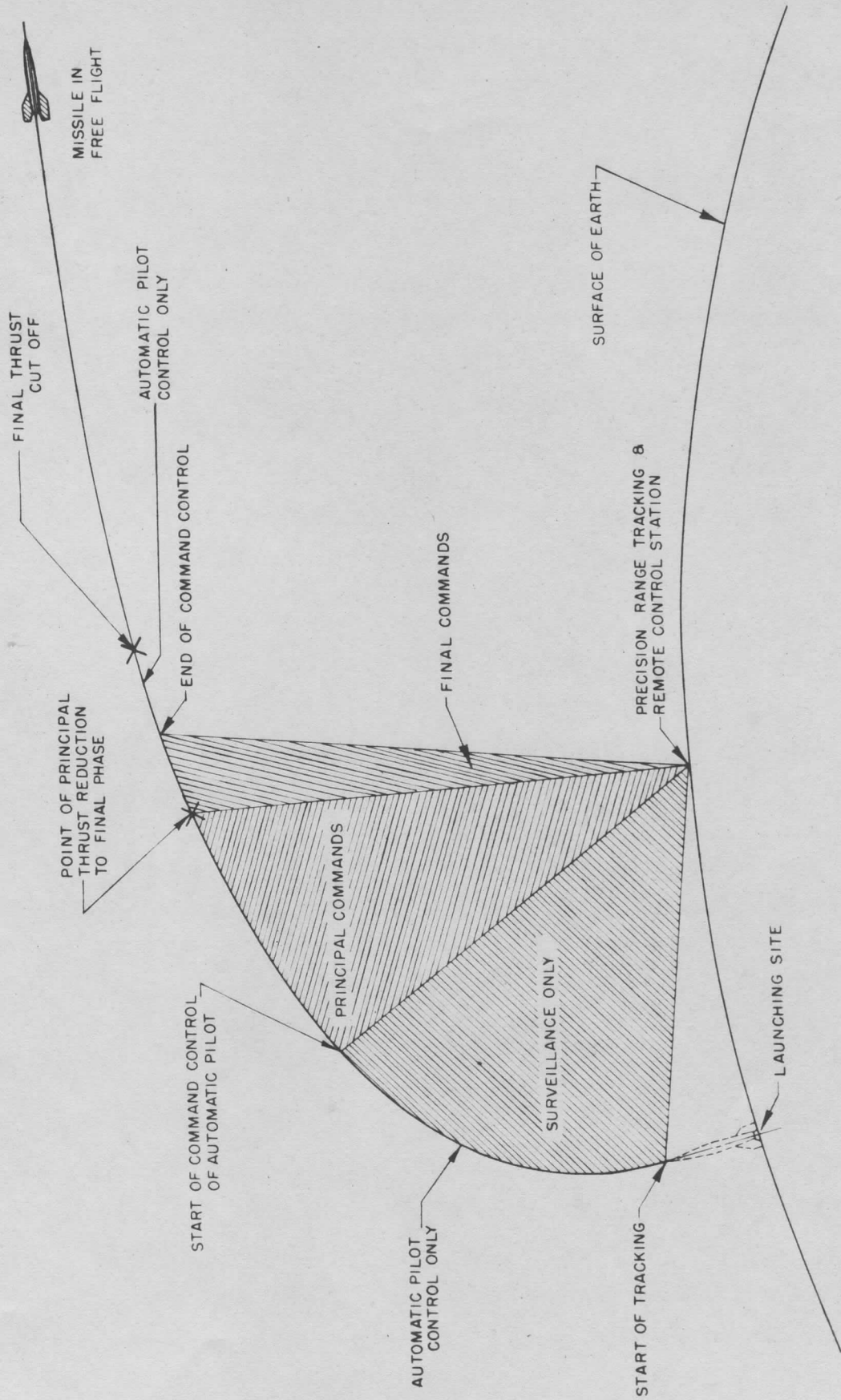

FIG. 1 - PROGRAM OF POWER PORTION OF FLIGHT

26-90

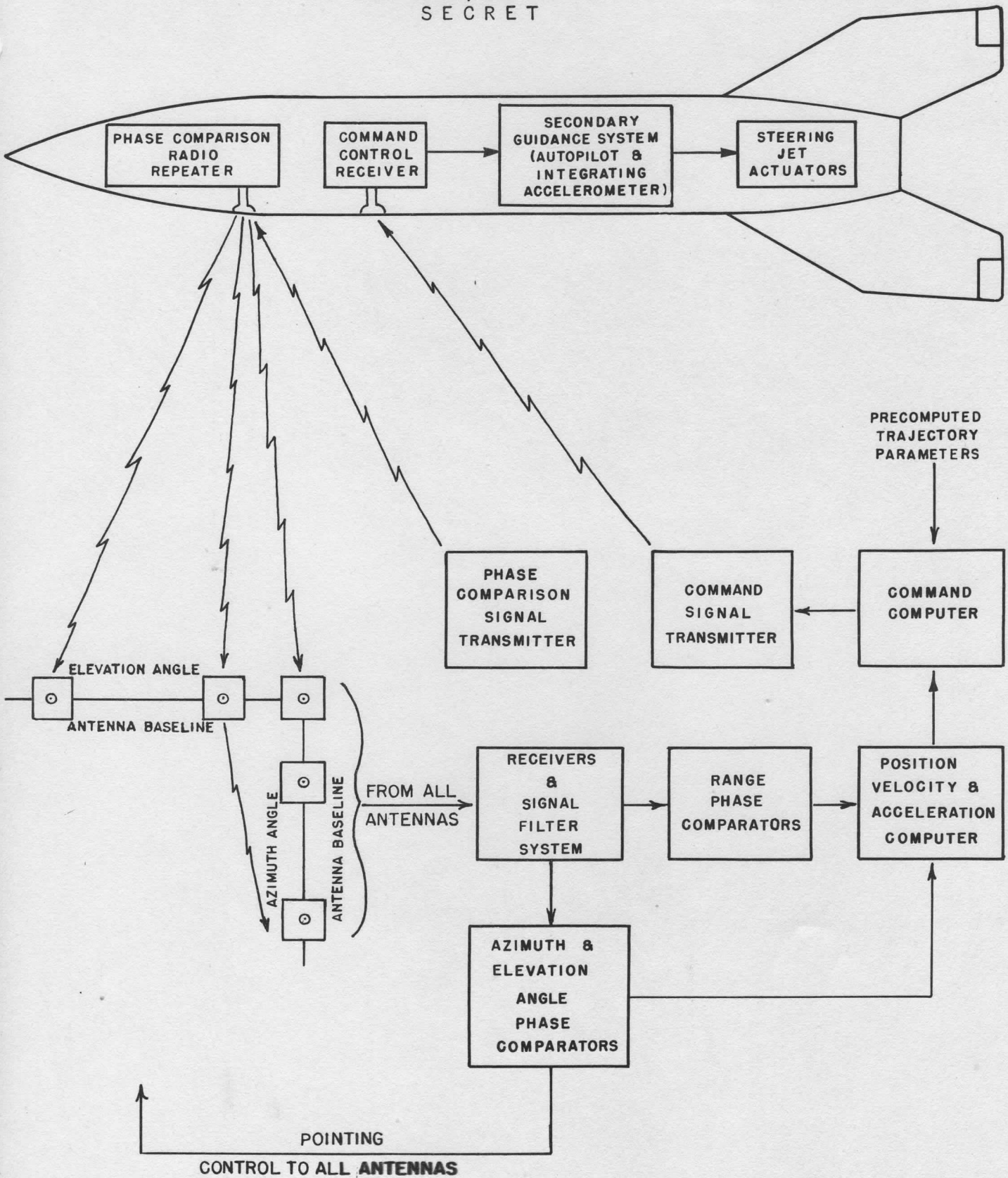

FIG. 2 - BLOCK DIAGRAM OF PRECISION TRACKING AND GUIDANCE SYSTEM

SECRET

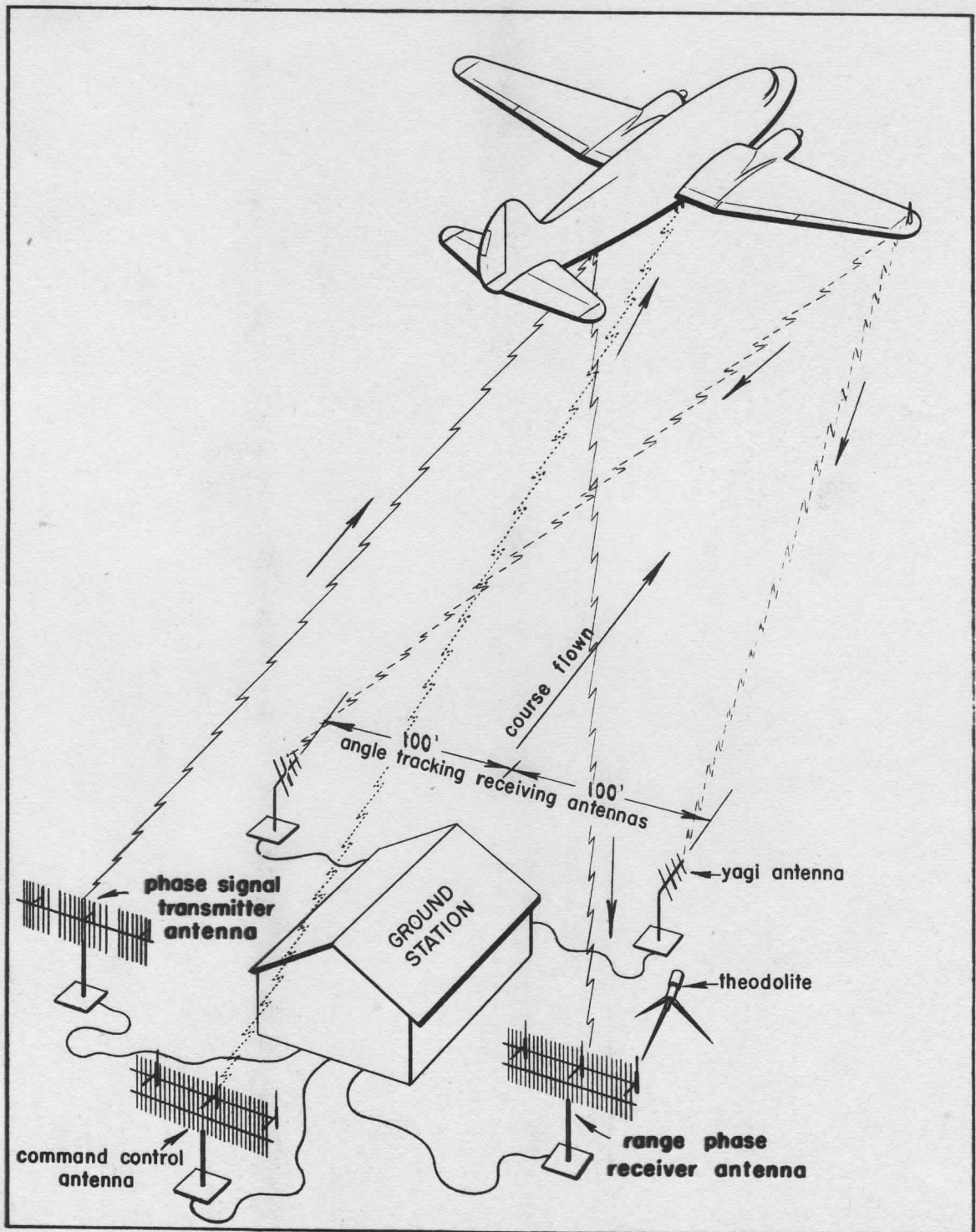

FIG. 3 - VHF GUIDANCE TEST SYSTEM ANTENNA ARRANGEMENT

SECRET

CONSOLIDATED VULTEEAIRCRAFT CORPORATION
SAN DIEGO, CALIFORNIA

MODEL MX-774
DATE 23 Nov 1948

SECRET

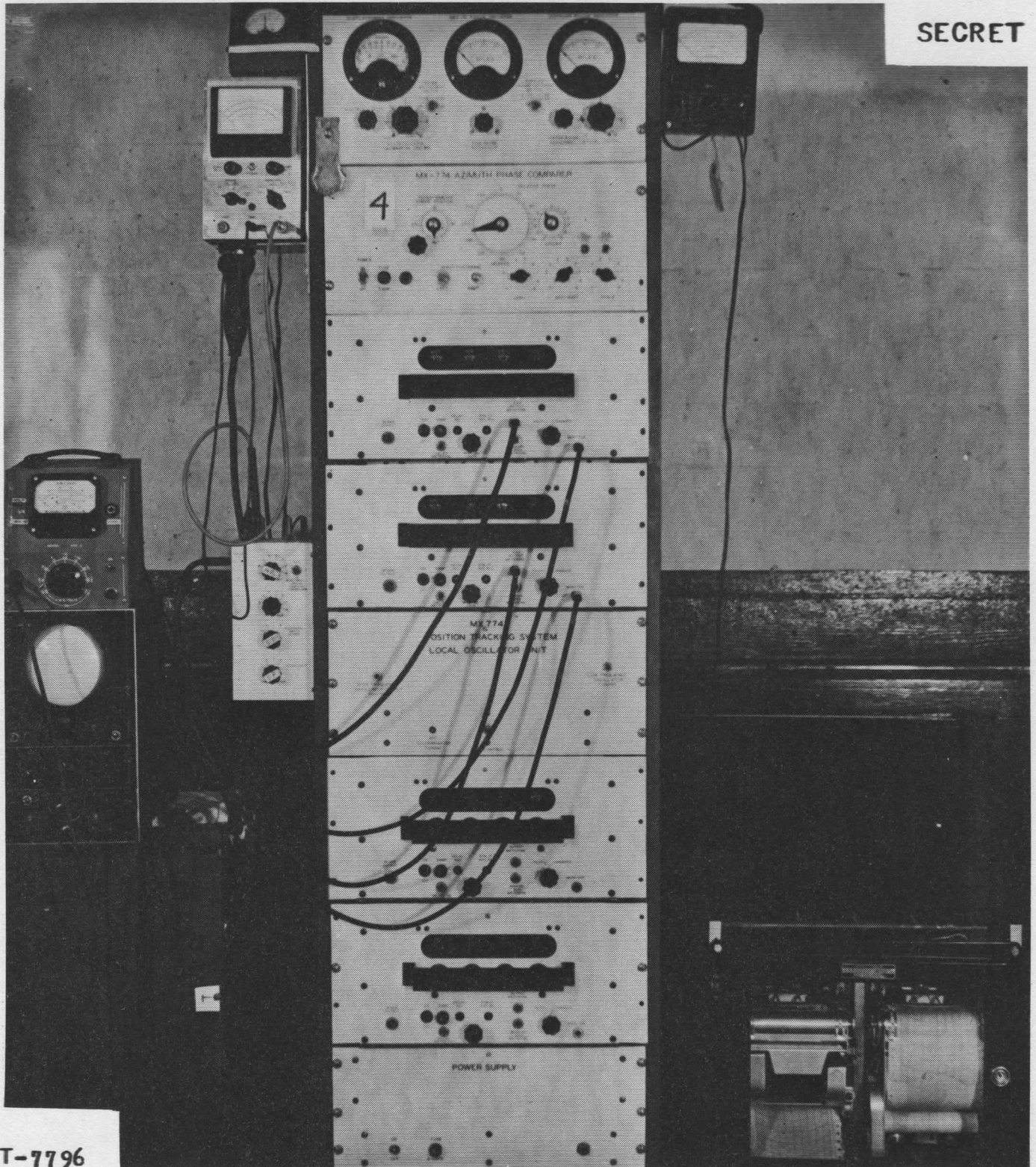

T-7796

FIG. 4 - POSITION TRACKER SYSTEM GROUND STATION OPERATIONAL TEST

SECRET

ANALYSIS
PREPARED BY
CHECKED BY
REVISED BY

CONSOLIDATED VULTEE AIRCRAFT CORPORATION

SAN DIEGO DIVISION
SECRET

PAGE 93
REPORT NO ZP-48-35003
MODEL APPENDIX C
DATE NOV. 23, 194

A P P E N D I X C
D E S I G N D A T A
F O R
3000 LB WARHEAD, 1000 MILE MISSILE

INTRODUCTION

A preliminary design and performance estimate was previously submitted on a 3000 lb., 1000 mile missile. This study formed part of a report entitled "The Applications of MX-774 Accomplishments to the Advancement of the Guided Missile Art".

Only very sketchy substantiating material was submitted at that time. The purpose of Appendix C is to present in more complete form the technical data on which this design was based.

STABILITY AND CONTROL
(3,000 pound warhead - 1,000 mile missile)

A. GENERAL:

The 3,000 pound warhead, 1,000 mile missile is stabilized by four (4) modified arrowhead fins of 12 sq. ft per panel (in the booster stage). The fins are designed to give the missile a minimum margin of static stability of two percent body length at the most critical condition (see page 102). It was possible to design relatively small fins due to the excellent aerodynamic characteristics of the modified arrowhead fin due to the forward position of the center of gravity obtained by placing the warhead in the nose of the missile.

In the final stage of powered flight it is possible to maintain a two percent margin of static stability at the most critical condition with only 9 sq. ft. per panel. This results from the forward shift in center of gravity due to the ejection of two 20,000 pound thrust rocket motors and related equipment. (see page 102). Thus 3 sq. ft. per panel of fin and body skin on the aft portion of the missile may also be ejected at separation.

The 3,000 pound warhead will be stabilized by a conical tail during the entry into the atmosphere.

Two (2) 20,000 pound thrust rocket motors and four (4) 2,000 pound thrust rocket motors are used to control the missile in pitch, yaw and roll.

B. LIFT AND MOMENT CHARACTERISTICS:

1. Body Alone

The lift and moment distribution over the body alone for the 3,000 pound warhead, 1,000 mile missile were determined by the same method as used in Appendix A and have been presented on pages 98 and 99 for various Mach numbers.

The normal force coefficient and center of pressure locations for the body alone are calculated by

$$\frac{dC_{N_B}}{d\alpha} = \frac{4}{\beta} \sum F_n R_n \Delta X$$

$$\frac{X_B}{l} = \frac{R \sum F_n R_n X \Delta X}{l \sum F_n R_n \Delta X}$$

STABILITY AND CONTROL (Cont'd)

B. LIFT AND MOMENT CHARACTERISTICS: (Cont'd)

and their variation with Mach number is presented on page 100.

2. Fin Alone

The lift and center of pressure characteristics of the fins for both the booster stage and final stage were determined by the same method as used in Appendix A. Plots of $dC_{NF}/d\alpha$ and X_F/l for the fin of the booster stage are presented on page 101.

3. Complete Missile

The center of pressure locations for the complete missile are calculated by

$$\frac{X}{l} = \frac{(1 - \frac{X_B}{l} - \frac{X_F}{l}) dC_{NB}/d\alpha}{2 dC_{NF}/d\alpha + dC_{NB}/d\alpha} + \frac{X_F}{l}$$

The variation of center of pressure with Mach number for both the booster stage and final stage of the complete missile are shown on page 102 along with the center of gravity variations for both stages. These plots show the margin of static longitudinal stability.

4. Trim Angles of Attack

The trim angles of attack were obtained by the following relationship:

$$\alpha_{trim} = \frac{C_{mJ}}{dC_m/d\alpha}$$

where $C_{mJ} = \frac{T_1 \sin 2^\circ (X_{c.g.} - X_J)}{q S_B d}$

$T_1 = 40,000$ lbs.

$X_J = 1.0$ ft.

$S_B = 31.5$ sq.ft.

$d = 6.33$ ft.

and

$$\frac{dC_m}{d\alpha} = \frac{(2 dC_{NF}/d\alpha + dC_{NB}/d\alpha)(X_{c.g.} - X)}{d}$$

STABILITY AND CONTROL (Cont'd)

B. LIFT AND MOMENT CHARACTERISTICS: (Cont'd)

The variation of trim angles of attack with Mach number are presented on page 103 for the 3,000 pound warhead, 1,000 mile missile.

ROC
(3000)
LIFT D
AT W

0.4
0.3
0.2
0.1
0
0 20 40 60
 F_{hR}

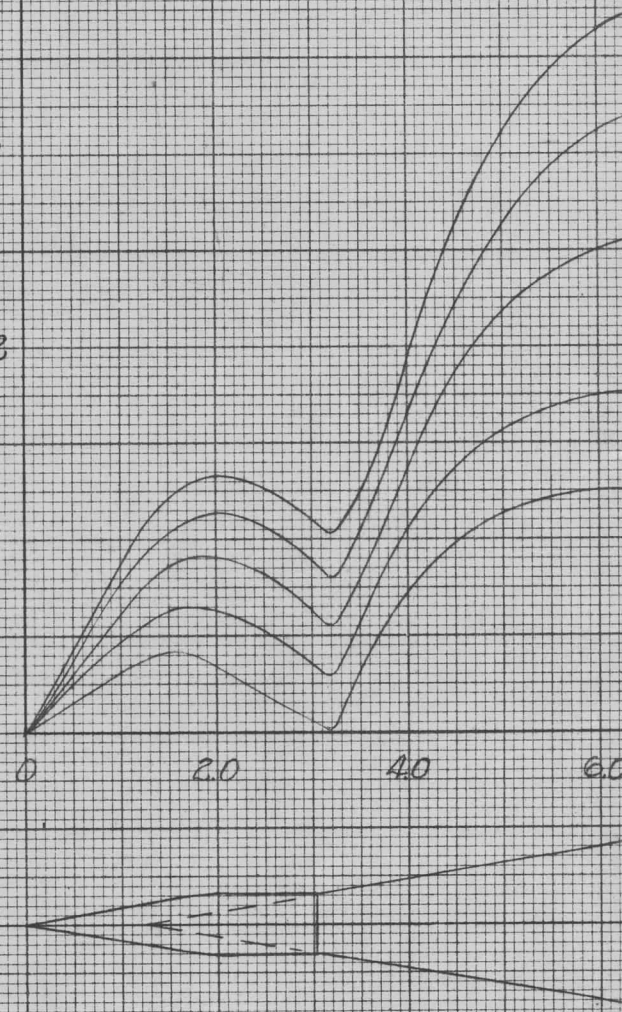

X = DISTANCE

STC 3000



JET TYPE MISSILE
(LB. WARHEAD - 1000 MI.)
DISTRIBUTION ON BODY ALONE
VARIOUS MACH NUMBERS

$$\sum F_n R_n \Delta X = a/a_0$$

$$a = dC_n/d\alpha$$

$$a_0 = 4/\beta$$

$$\beta = \sqrt{M^2 - 1}$$

$$C_{NB} = N_B/q S_B$$

$$R_0 = \text{MAXIMUM RADIUS} = 38''$$

$$R = \text{LOCAL RADIUS} \text{ IN.}$$

$$R_N = R/R_0 \text{ AT } N^{\text{th}} \text{ STATION}$$

$$\alpha = \text{ANGLE OF ATTACK} \text{ RADIANS}$$

$$M = \text{MACH NUMBER}$$

$$N_B = \text{BODY NORMAL FORCE} \text{ LB.}$$

$$q = \text{DYNAMIC PRESSURE} \text{ LB/SQFT.}$$

$$S_B = \text{MAXIMUM BODY CROSS-SECTIONAL AREA} = 31.5 \text{ SQ.FT.}$$

$$L = 47.8 \text{ FT.}$$

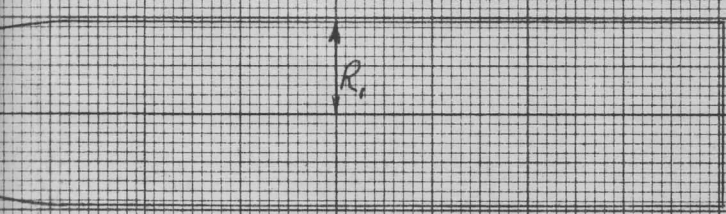
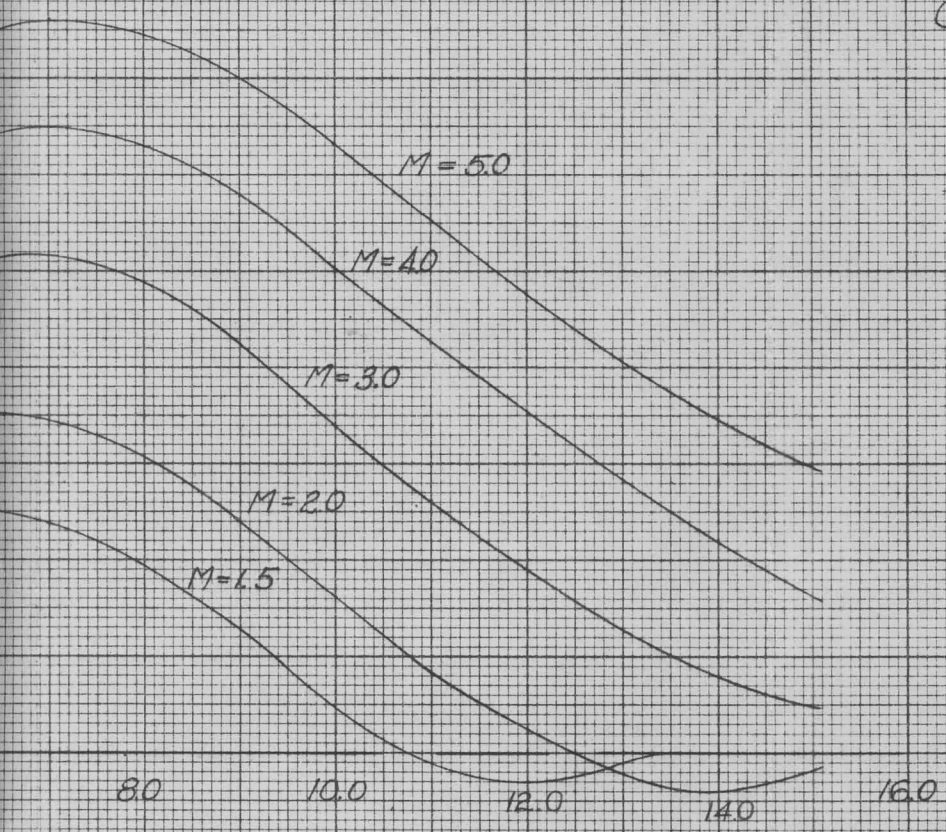

AFT OF NOSE - MAXIMUM RADII

NOV. 23, 1948

CALCULATED BY			PAGE
TRACED BY			DOC. NO.
CHECKED BY			MODEL
APPROVED BY			
APPROVED BY			
CONSOLIDATED AIRCRAFT CORPORATION LINDBERGH FIELD, SAN DIEGO, CALIF.			

ROCKET
(3000 LB.)
MOMENT DISTRIBUTION
VARIOUS

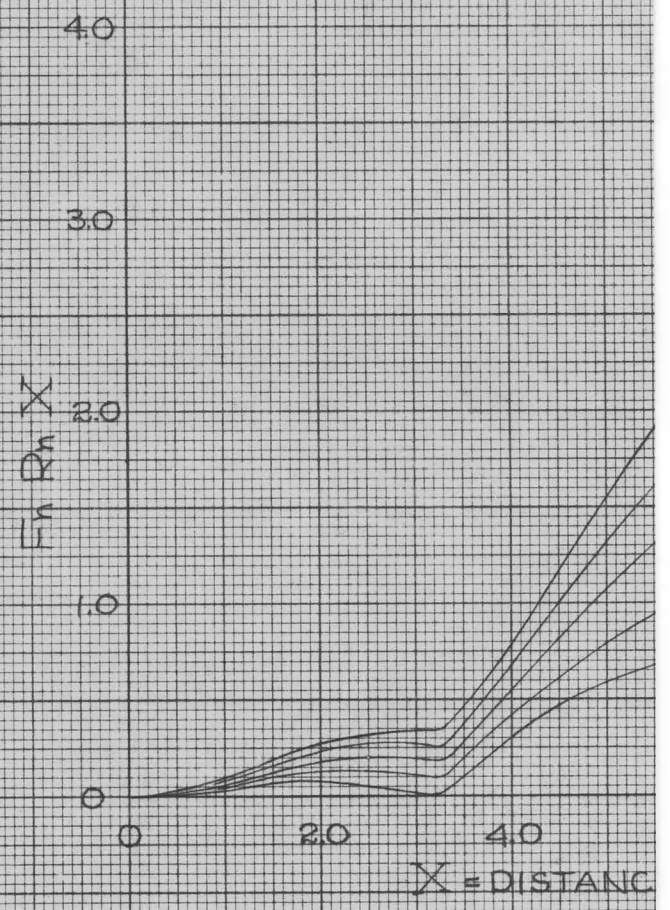

S + C 3000



TYPE MISSILE
(WARHEAD - 1000 MI.)
ON BODY ALONE AT
MACH NUMBERS

$$\frac{dC_{mB}}{d\alpha} = \frac{2}{\beta} \sum F_n R_n X \Delta X$$

$$C_{mB} = N_B \bar{X}_B / \rho S_B d$$

R_0 = MAXIMUM RADIUS = 38 IN.

R = LOCAL RADIUS ~ IN.

$R_n = R/R_0$ AT n^{th} STATION

α = ANGLE OF ATTACK ~ RADIANS

M = MACH NUMBER

$$\beta = \gamma M^2 - 1$$

N_B = BODY NORMAL FORCE ~ LBS.

ρ = DYNAMIC PRESSURE ~ LB/SQ. FT.

S_B = MAXIMUM BODY CROSS-SECTIONAL AREA = 31.5 SQ. FT.

d = MAXIMUM BODY DIAMETER = 3.17 FT.

\bar{X}_B = LONGITUDINAL DISTANCE MEASURED AFT OF NOSE TO C.P. BODY ~ FT.

$l = 47.8$ FT.

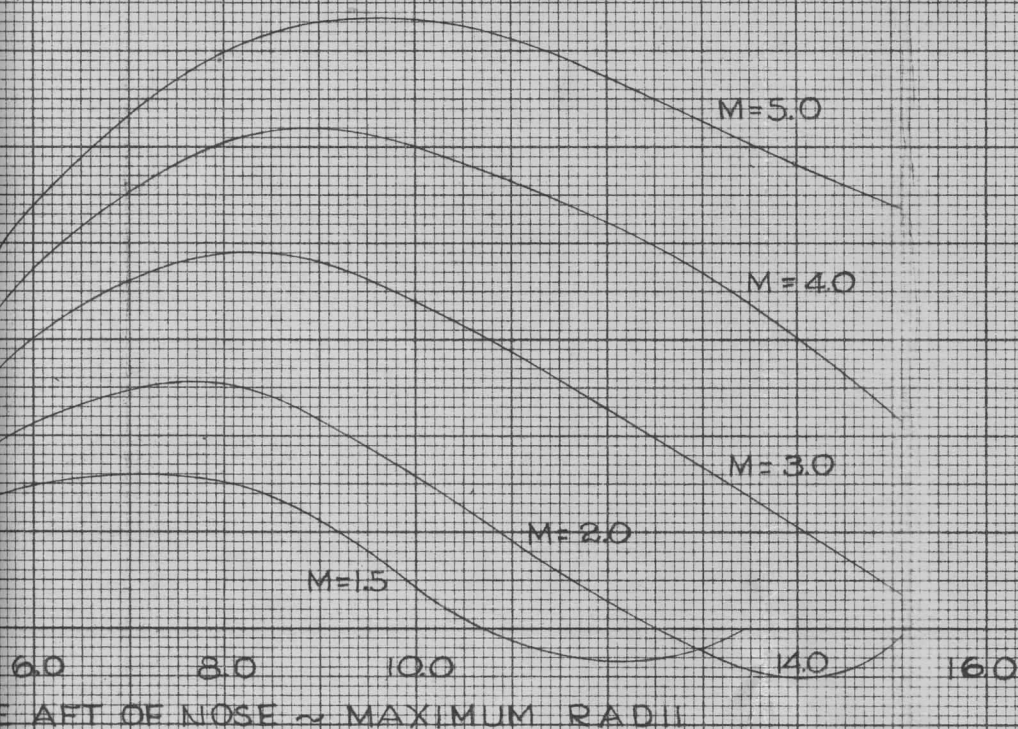

Nov. 23, 1948

CALCULATED BY			PAGE
TRACED BY			DOC. NO.
CHECKED BY			MODEL
APPROVED BY			
APPROVED BY			
CONSOLIDATED AIRCRAFT CORPORATION LINDBERGH FIELD, SAN DIEGO, CALIF.			

SECRET

ROCKET TYPE MISSILE
(3000 LB WARHEAD-1000 MI.)

VARIATION OF CENTER OF PRESSURE LOCATION AND
NORMAL FORCE COEFFICIENT PER DEGREE ANGLE OF
ATTACK WITH MACH NUMBER FOR BODY ALONE.

x_B = C.P. LOCATION FOR BODY ALONE MEASURED
AFT OF NOSE ~ FT.

l = BODY LENGTH = 47.8 FT.

$C_{NB} = N_B / q S_B$

N_B = BODY NORMAL FORCE - LB.

q = DYNAMIC PRESSURE - LB/SQ. FT.

S_B = MAX. BODY CROSS-SECTION AREA ~ 31.5 SQ. FT.

α = ANGLE OF ATTACK ~ DEG.

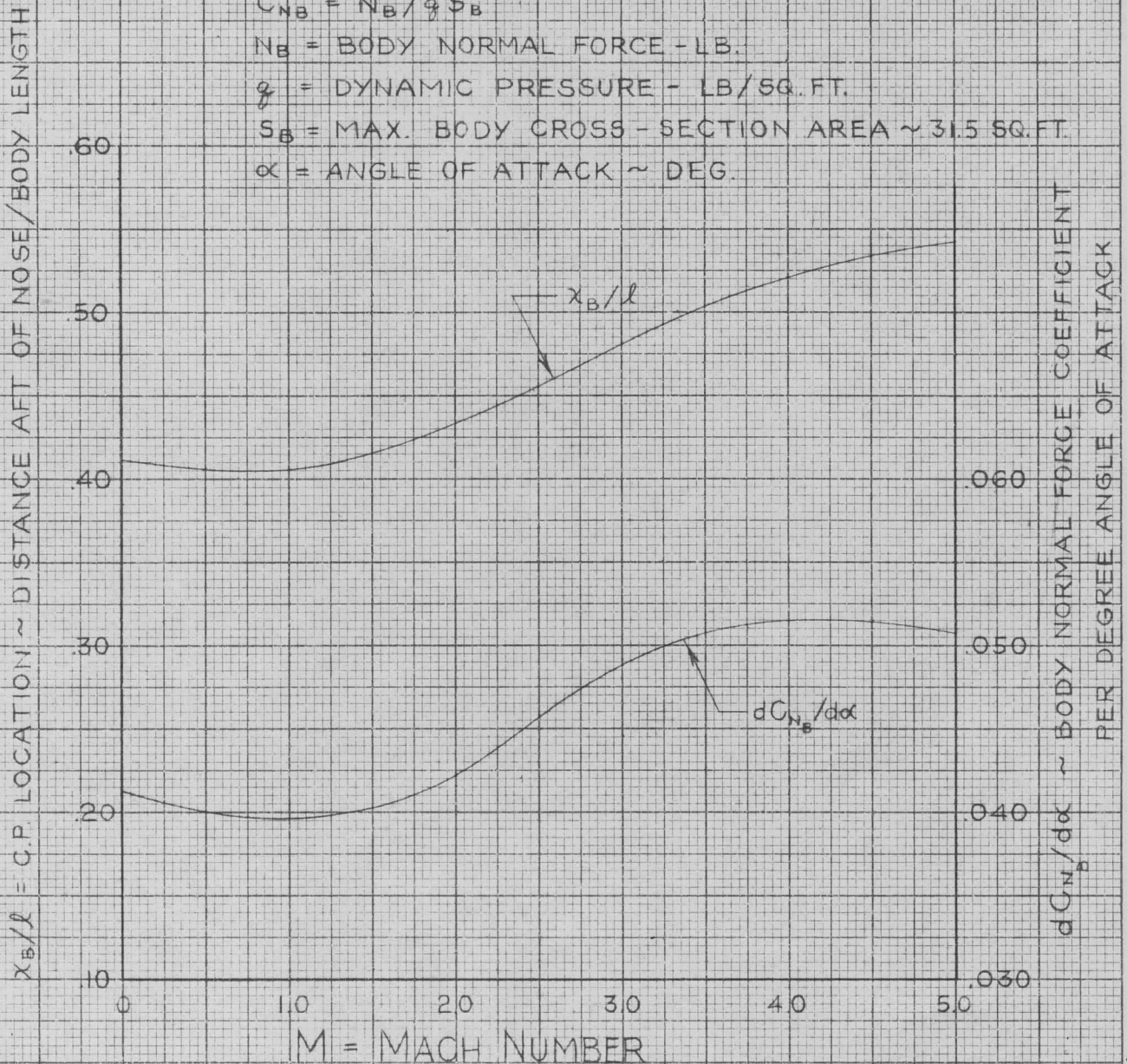

SECRET

Nov. 23, 1948

NO. 329-11. 10 X 10 to the post inch, 2 1/2 lines spaced.

Engraving, 1 X 10 in.

542 3000
KENNEL & ESSER CO.

SECRET

ROCKET TYPE MISSILE
(3000 LB WARHEAD-1000 MI.)

VARIATION OF CENTER OF PRESSURE LOCATION AND
NORMAL FORCE COEFFICIENT PER DEGREE ANGLE OF
ATTACK WITH MACH NUMBER FOR FIN ALONE.

(INCLUDING UPWASH AND BODY CARRY-OVER)

x_F = C.P. LOCATION FIN MEASURED FROM
BASE OF BODY ~ FT.

l = BODY LENGTH = 47.8 FT.

$C_{NF} = N_F / q S_B$

N_F = FIN NORMAL FORCE ~ LB.

q = DYNAMIC PRESSURE ~ LB/SQ.FT.

S_B = MAX. BODY CROSS-SECTION AREA = 31.5 SQ.FT.

α = ANGLE OF ATTACK ~ DEG.



$dC_{NF}/d\alpha$ = FIN NORMAL FORCE COEFFICIENT PER PANEL
PER DEGREE ANGLE OF ATTACK FOR BOOSTER STAGE FINE

NO. 328-11. 10 x 10 to the left inch, 2 1/2 inch secured.
 Enlarging 1 x 10 in.
 MADE IN U.S.A.

54C 3000
 KENNEL & ESSER CO.

SECRET

Nov. 23, 1948

SECRET

ROCKET TYPE MISSILE
 (3000 LB WARHEAD ~ 1000 MI)

CENTER OF PRESSURE AND CENTER OF GRAVITY LOCATION
 AS A FUNCTION OF MACH NUMBER FOR MAXIMUM RANGE CONDITION

\bar{x}/l AND $x_{c.g.}/l$ = C.P. AND C.G. LOCATION ~ DISTANCE FWD OF BASE / BODY LENGTH

\bar{x} = C.P. LOCATION MEASURED FROM
 BASE OF BODY ~ FT.

$x_{c.g.}$ = C.G. LOCATION MEASURED FROM
 BASE OF BODY ~ FT.

l = BODY LENGTH = 47.8 FT.

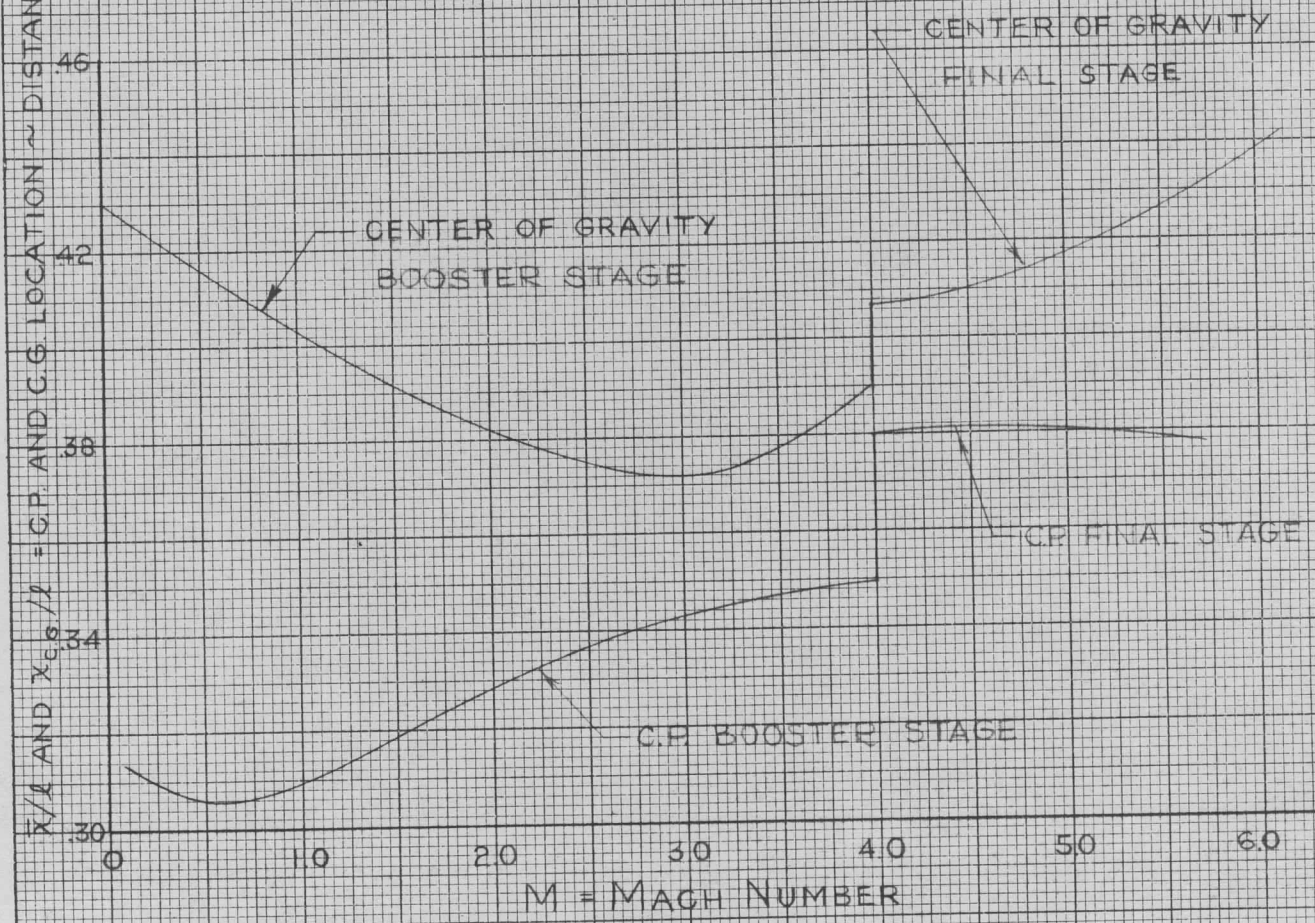

CHARLES BRUNING COMPANY, INC.
 30 x 50 to the inch.
 NO. 100-50
 54C 3000
 DATA SHEETS

SECRET

Nov. 23, 1948

SECRET

ROCKET TYPE MISSILE
 (3000 LB. WARHEAD - 1000 MI.)

TRIMMED ANGLE OF ATTACK IN PITCH AS A FUNCTION
OF MACH NUMBER FOR MAXIMUM RANGE CONDITION

$$\alpha_{\text{TRIM IN PITCH}} = \frac{C_{m,T}}{dC_m/d\alpha}$$

ANGLE OF DEFLECTION:
 ROCKETS ~ 2° PER ROCKET

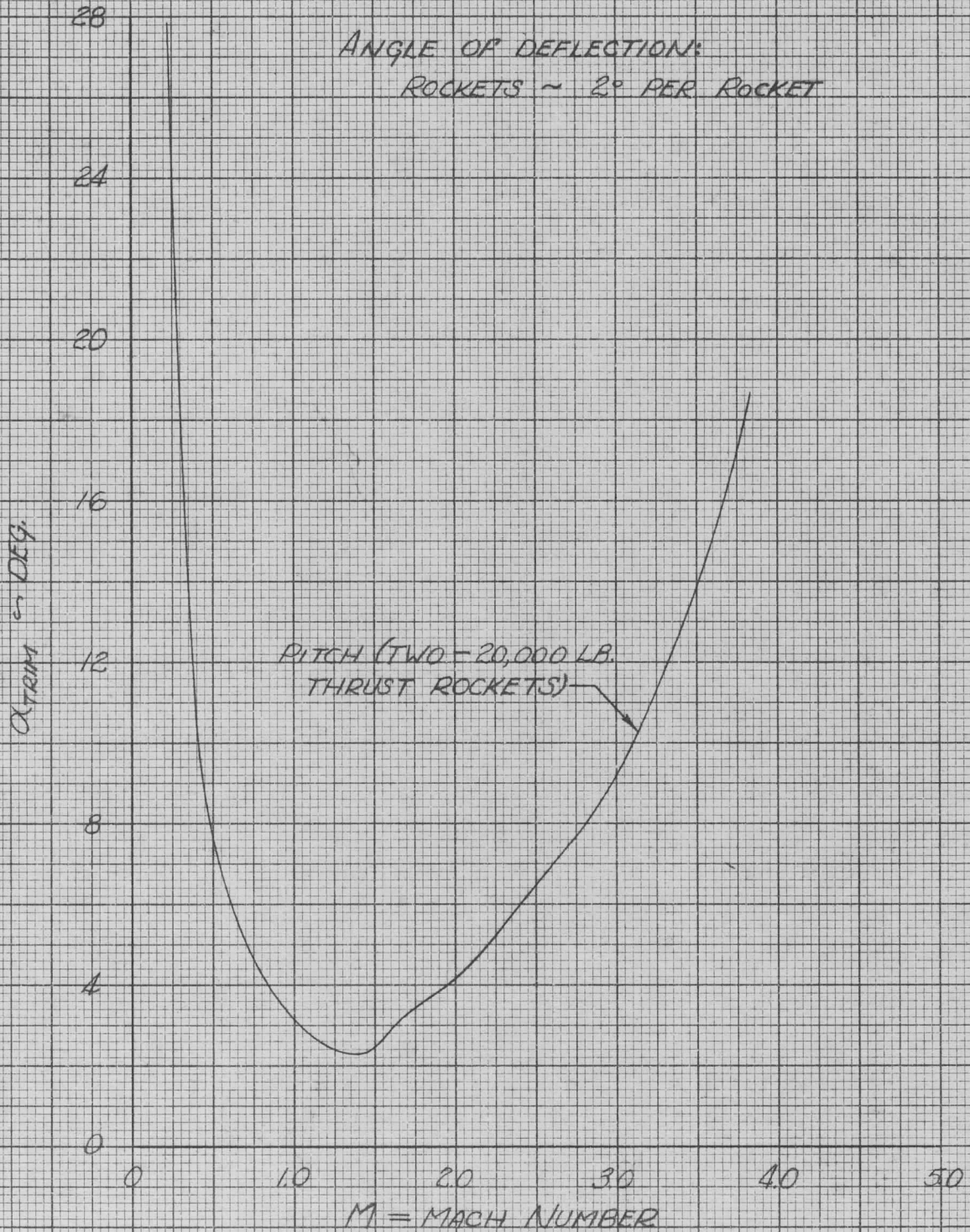

NO. 328-11 10 X 10 to the first inch, 2 1/2 inches secured.

545 3000
 KENNEL & ESSER CO.

SECRET

Nov. 23, 1948

WEIGHT JUSTIFICATION OF
MISSILE WITH 3000 LBS. WARHEAD

This is a brief discussion of the basis on which the weight breakdown is founded. Preliminary stress calculations furnished the structure material gauges. Power plant and equipment item weight are based on existing or comparable item weights.

A. PAYLOAD-

The payload consists of a warhead (3000 lbs.) and a skirt. The skirt is to be 19" long, upper diameter 27" and lower diameter 33"; material in $\frac{1}{4}$ " steel plate.

B. BODY-

For convenience of calculating, the body is divided into a number of sections and is not intended to indicate the actual sectional breakdown of the body. All material used in the body section is aluminum unless otherwise noted.

SEPARATION RING. This ring has a cross sectional area of 1.2 sq. in.

FUEL TANKS. The tanks cylinder sections are to be made of .072 sheet. They are made up of quarter sections longitudinally and reinforced at the joints by two (2) $\frac{3}{16}$ x 1 $\frac{1}{2}$ doublers.. Joints are butt welded. The ends are spherical segments of .072 sheet. $\frac{3}{16}$ x 1 $\frac{1}{2}$ doublers are added where the ends are welded to tank cylinder.

BODY - FORWARD OF LOX TANK)

BODY - BETWEEN TANKS) These body cylinders are constructed of .072 sheet, and $\frac{3}{16}$ x 1 $\frac{1}{2}$ circular doubler is added at the tank juncture point.

BODY - AFT OF ALCOHOL TANK. The cylinder skin of this section .064 sheet and has $\frac{3}{16}$ x 1 $\frac{1}{2}$ longitudinal doublers at the quarter joints. Frames and stringer weight is considered 20% of the skin weight.

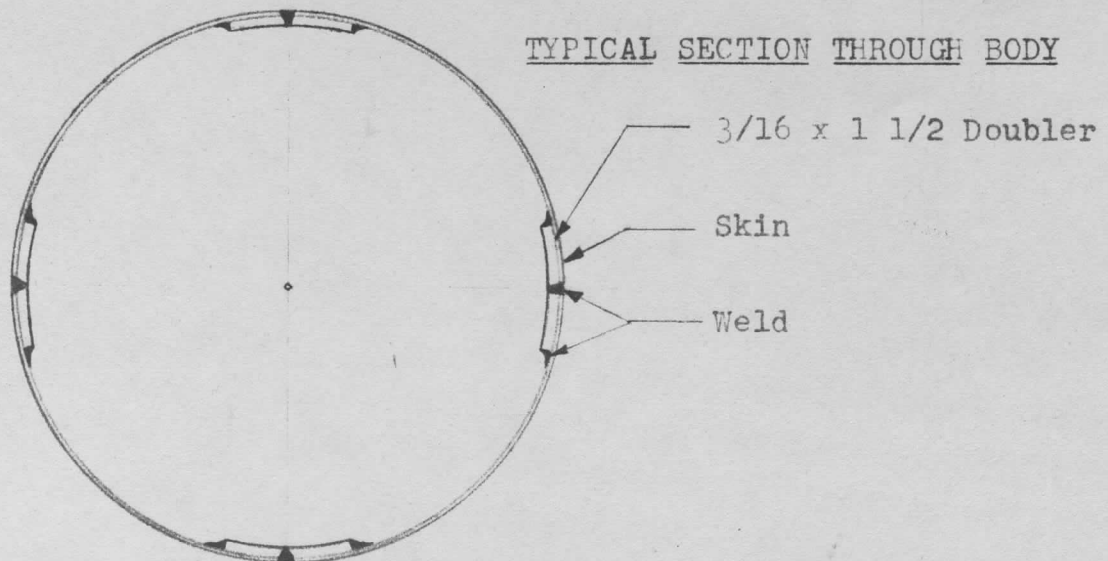

WEIGHT JUSTIFICATION OF
MISSILE WITH 3000 LBS. WARHEAD CONT'D.

C. FINS-

The fin weight is estimated to be 2.5 lbs./sq. ft., similar to the MX774.

D. POWER PLANT-

MOTORS AND PROPELLANT VALVES. The 2000 LBS. THRUST motors weight is the same as for the MX774. The weight of the 20,000 LBS. THRUST motors was obtained from an installation using identical motors. The propellant valve weights were proportioned to the valve weights on the MX774.

PUMPS. Proportioned to MX774 weight.

MOTOR MOUNTS. Estimated weight based on the use of 1 1/2 x .095 steel tubing.

LINES AND FITTINGS. Proportioned to the MX774 weight.

PRESSURE SUPPLY. The heat exchanger weight was proportioned to the MX774 weight. The large helium tank (Alcohol Pressure) weight is based on hemispherical ends 11 in. radius, 1/8 sheet. A .102 x 3 doubler joins the halves. All material of this tank is chrome molybdenum alloy.

PUMP PRESSURE SUPPLY. The H₂O₂ tanks are made of aluminum sheet stock. The first stage tank has a 12.5 radius, hemispherical ends, 1/8" sheet, and a 3" cylindrical section in between, 1/4" sheet. 1/4" and 1/8" doublers on the ends and cylinder respectively. The second stage tank has a 12" radius, hemispherical end, 1/8" sheet and a 1/4" x 3" doubler to join the halves.

E. FIXED EQUIPMENT-

ELECTRONIC SYSTEMS. The breakdown of all electronic system weights were estimated by the electronic section.

ENGINE SWIVEL AND TAB CONTROLS. Proportional to the MX774 weight.

WARHEAD EJECTION. Weight based on possible requirements.

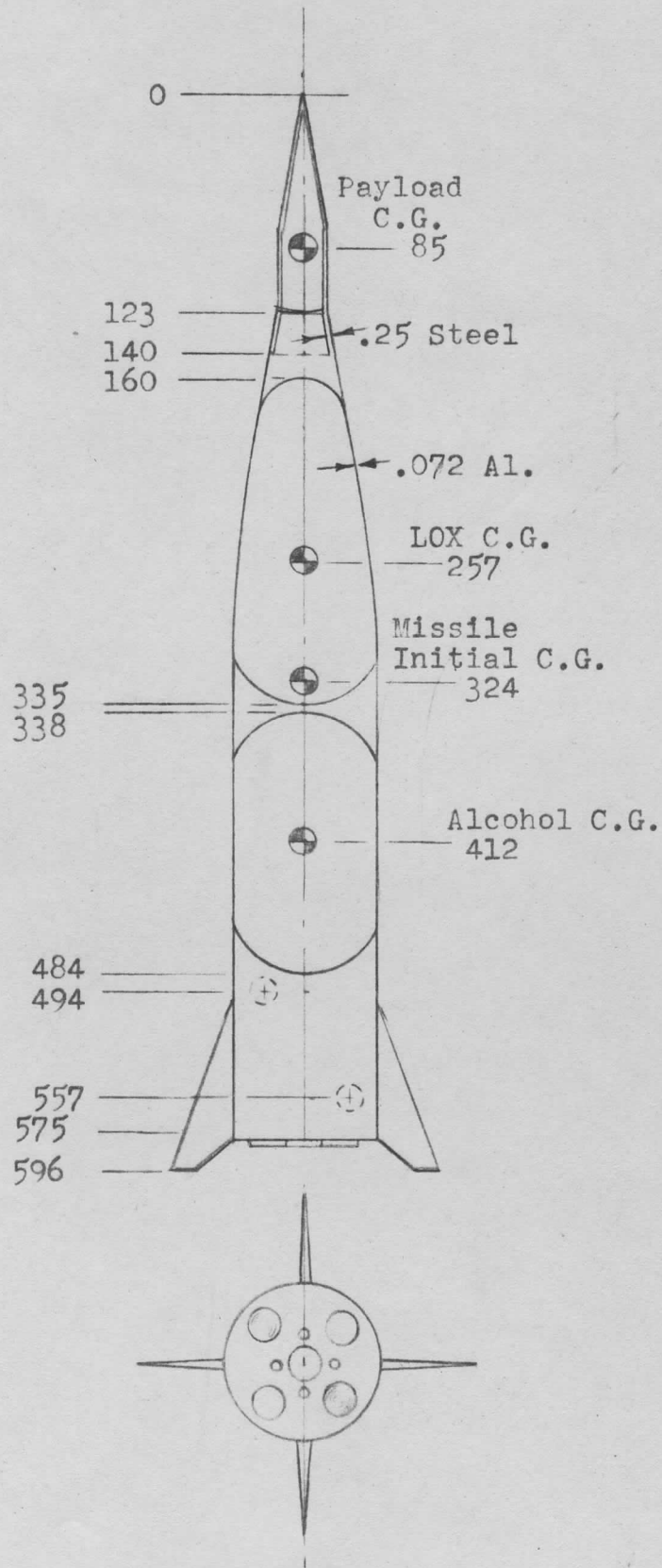

GROSS WEIGHT SUMMARY

(3000 lb Warhead, 1000 Mile Missile)

	<u>STAGE I</u>			<u>STAGE II</u>		
	<u>Weight</u>	<u>Arm</u>	<u>Moment</u>	<u>Weight</u>	<u>Arm</u>	<u>Moment</u>
<u>Gross Weight</u>	46261	323.9	14983628	19533	336.3	6568845
<u>Weight Empty</u>	(6761)	293.0	(1980678)	(5633)	243.1	(1369445)
Payload	3125		265625	3125		265625
Body	1169		432075	1132		411133
Fins (4)	120		66800	55		29425
Power Plant	1847		971658	944		489111
Equipment	500		244520	377		174151
<u>Fuel</u>	(39500)		(13002950)	(13900)		(5199400)
Hydrogen Peroxide	790		421070	300		148200
Liquid Oxygen	21560		5516080	7600		2333200
Alcohol	17150		7065800	6000		2718000

	<u>STAGE I</u>			<u>STAGE II</u>		
	<u>Weight</u>	<u>Arm</u>	<u>Moment</u>	<u>Weight</u>	<u>Arm</u>	<u>Moment</u>
<u>Payload</u>	(3125)		(265625)	(3125)		(265625)
Warhead	3000	83	249000	3000	83	249000
Skirt	125	133	16625	125	133	16625
<u>Body</u>	(1169)		(432075)	(1132)		(411133)
Separation Ring	16	170	2720	16	170	2720
Skin Fwd of Fwd Tank	40	155	6200	40	155	6200
Fwd Fuel Tank (Lox)	355	255	90525	355	255	90525
Skin & Struct (Between Tank)	78	336	26208	78	336	26208
Aft Fuel Tank, Incl. Tunnel (Alc)	460	416	191360	460	416	191360
Skin & Struct Aft Sect	210	528	110902	173	520	89960
Insulation - Alc. Tank Tunnel	10	416	4160	10	416	4160
<u>Fins</u> 4 @ 12 sq.ft @ 2.5 lbs/sq.ft	(120)	556	(66800)	(55)	535	(29425)
<u>Power Plant</u>	(1847)		(971658)	(944)		(489111)
Motors & Prop. Valves	(761)		(409924)	(377)		(203468)
(2) 20000 lb Thrust	384	538	206456			
(1) 20000 lb Thrust	192	538	103228	192	538	103228
(4) 2000 lb Thrust	125	552	69000	125	552	69000
(3) 20000 lb Prop. Valves	60	521	31240	60	521	31240

	<u>STAGE I</u>			<u>STAGE II</u>		
	<u>Weight</u>	<u>Arm</u>	<u>Moment</u>	<u>Weight</u>	<u>Arm</u>	<u>Moment</u>
<u>Power Plant (Cont'd)</u>						
Pumps	(270)		(135900)	(120)		(60000)
(1) 40000 lb Thrust	150	506	75900			
(1) 28000 lb Thrust	120	500	60000	120	500	60000
Mounts	(214)		(113336)	(110)		(56760)
40000 lb Thrust	104	544	56576			
28000 lb Thrust	110	516	56760	110	516	56760
Valves & Regulators	(75)	515	(38625)	(75)	515	(38625)
Lines & Fittings	(200)		(103100)	(100)		(51400)
(2) 20000 lb Thrust	100	517	51700			
28000 lb Thrust	100	514	51400	100	514	51400
Pressure Supply	(115)		(62850)	(40)		(19400)
Heat Exchanger	20	510	10200	20	510	10200
He Tank (Alc.Press.)	75	558	41850			
He Tank (Contr.Opr.)	10	516	5160	10	516	5160
Helium Gas	10	564	5640	10	440	4040
Pump Propulsion Sys.	(77)		(40873)	(32)		(15808)
H.O. Tanks(Large)	45	557	25065			
H.O. Tanks(Small)	32	494	15808	(32)	494	15808
Residual Fuel	(135)	497	(67050)	90	485	(43650)

	<u>STAGE I</u>			<u>STAGE II</u>		
	<u>Weight</u>	<u>Arm</u>	<u>Moment</u>	<u>Weight</u>	<u>Arm</u>	<u>Moment</u>
<u>Fixed Equipment Group</u>	(500)		(244520)	(377)		(174151)
Stabilization	(165)	(503)	(82995)	(132)	(503)	(66396)
(4) Amplifiers	20			20		
(5) Gyros	22			22		
(6) Valves	36			18		
(6) Response Units	30			15		
Inverters	12			12		
Batteries	30			30		
Misc (Wire, Brkt, Etc.)	15			15		
Command-Doppler-Range	(70)	503	(35210)	(70)	503	(35210)
Command	27			27		
Range & Doppler	25			25		
Batteries	18			18		
Phase Comparator Trans.	(65)	(503)	(32695)	(65)	(503)	(32695)
Unit	50			50		
Batteries	15			15		
Eng. & Tabs Swivel Controls	(130)	(532)	(75200)	(50)	(532)	(26600)
Staging Provisions	(20)	518	(10370)	(10)	520	(5200)
Warhead Ejection	(50)	161	(8050)	(50)	161	(8050)
<u>Fuel</u>	(39500)		(13002950)	(13900)		(5199400)
H ₂ O ₂	790	533	421070	300	494	148200
Lox	21560	257	5516080	7600	307	2333200
Alc	17150	412	7065800	6000	453	2718000
<u>Total Missile (Initial)</u>	46261	323.9	14983628	19533	336.3	6568845

STRUCTURES

Loads Analysis

The loads analysis for the 3000 lb warhead missile is very similar to that for the 6000 lb warhead missile (Ref. Appendix *A* page *60*) except for the additional analysis here of the gust loads on the missile.

Maneuver Condition

Data presented here for maneuver condition is similar to that shown for the 6000 lb warhead missile (Ref. Appendix *A* page *60*). These data are presented on pages *112* to *113*.

SECRET

THRUST & MACH NO AGAINST ALTITUDE

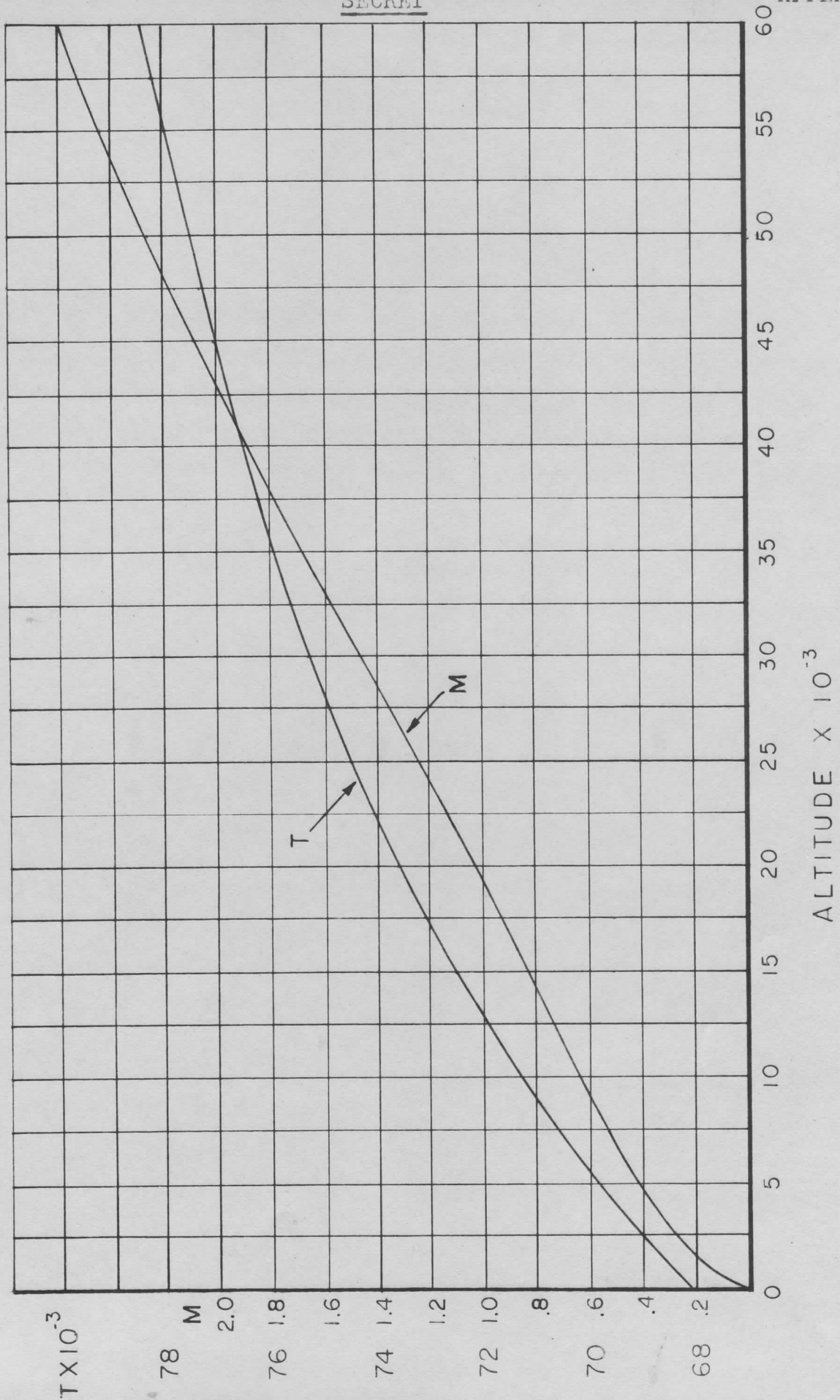

SECRET

MANEUVER LOADS

3000# WARHEAD

$q = 1481\lambda M^2$ $Load = \frac{dCN}{d\alpha} \times (2 \times 1.414\alpha_{trim}) \times q \times S$ $s = 31.5 \text{ sq.ft.}$

1	2	3	4	5	6		7	8	9	10	11		12
					dCN/dα	Body					Fin	Thrust	
Alt.	M	λ	qs	dtrim	Body	Fin	Body Load	Fin Load	Thrust	Thrust	1/2 Thrust x sin 20° x 1.414	1/2 Thrust x sin 20° x 1.414	Total Load
	Ref. Pg. 112		4665.5 XAM ²	Ref. Pg. 103	Ref. Pg. 100	Ref. Pg. 101	2x1.414x ⑥ x ④ x ⑤	2x1.414x ④ x ⑦ x ⑤	Ref. Pg. 112	⑧ x ③488 2 x 1.414	⑧ + ⑨ + ⑪		
5,000	.415	.8320	6685	9.6	.0402	.0201	7296	3648	69800	1722	9222	1722	9222
10,000	.640	.6876	13137	5.8	.0398	.0209	8576	4504	71220	1756	11324	1756	11324
15,000	.833	.5642	18264	4.1	.0396	.0219	8386	4638	72500	1788	11236	1788	11236
18,000	.950	.4992	21017	3.4	.0395	.0228	7982	4607	73200	1805	10784	1805	10784
20,000	1.030	.4593	22733	3.05	.0395	.0235	7746	4608	73600	1815	10539	1815	10539
22,000	1.115	.4221	24478	2.750	.0395	.0237	7519	4512	74000	1825	10206	1825	10206
25,000	1.243	.3709	26731	2.45	.0397	.0217	7353	4019	74500	1837	9535	1837	9535
30,000	1.483	.2967	29619	2.4	.0400	.0188	8041	3780	75300	1857	9964	1857	9964
35,000	1.683	.2351	31061	3.250	.0406	.0175	11591	4996	75950	1873	14714	1873	14714
40,000	1.885	.1852	30700	3.850	.0415	.0168	13871	5615	76520	1887	17599	1887	17599
45,000	2.083	.1458	28947	4.450	.0425	.0159	15482	5792	77040	1900	19374	1900	19374
50,000	2.255	.1149	27258	5.3	.0439	.0151	17935	6169	77450	1910	22194	1910	22194
55,000	2.420	.0905	24725	6.1	.0450	.0146	19194	6227	78000	1924	23497	1924	23497
60,000	2.595	.0712	22369	6.9	.0465	.0141	20297	6155	78400	1934	24518	1934	24518
65,000	2.760	.0561	19939	7.650	.0475	.0136	20490	5867	78800	1944	24413	1944	24413

Gust Condition

Gust loads will be computed on the basis of a sharp-edged gust normal to the longitudinal axis of the missile and of magnitude $50/\sqrt{\sigma}$ feet per second.

The expression for computing gust air loads is as follows:

$$\text{Air Load} = \frac{dC_l}{d\alpha} \times \alpha \times \frac{\rho}{\rho_0} \times \frac{\rho_0}{2} \times V^2 \times S$$

α in radians is equal to $\tan^{-1} U/V$, or for small angles, is equal to U/V (where U = gust velocity and V = speed of missile along trajectory).

The critical point on the flight path is where maximum fin load occurs. Loads on fin and body are tabulated on page 113 for the critical region of the flight path, from which the critical gust condition is determined. Shear and bending moment tables include the effects of the critical air loads plus the inertia forces acting to produce equilibrium. For preliminary analysis the inertia forces used are those based on initial weight of missile. This is somewhat conservative since the loss of weight in flight is near the cg while the air loads are concentrated toward the ends.

MISSILE LOADS
3000# WARHEAD

GUST CONDITION

1	2	3	4	5	6	7	8		9	10	11
							$\partial C_N / \partial \alpha$				
ALT.	M	V	σ	$1/\sqrt{\sigma}$	U	$\Delta \alpha$	Body Ref. Pg. 100	Fin Ref. Pg. 101	Body	Air Load	Fin
	Ref. Pg // 2	Ref. $\textcircled{2}$	P/Po	$1/\sqrt{(4)}$	50 x (5)	Tan $-\frac{U}{V}$			*	*	*
5,000	.415	455	.8616	1.0773	53.80	6.790	.0402	.0201	1820	910	
10,000	.640	689	.7384	1.1637	58.20	4.850	.0398	.0209	2560	1330	
15,000	.833	880	.6291	1.2608	63.04	4.100	.0396	.0219	2990	1640	
17,000	.910	954	.5891	1.3029	65.15	3.920	.0395	.0225	3100	1790	
18,000	.950	992	.5698	1.3247	66.24	3.820	.0395	.0228	3180	1840	
19,000	.993	1032	.5509	1.3475	67.37	3.730	.0395	.0231	3250	1900	
20,000	1.030	1069	.5327	1.3701	68.50	3.680	.0395	.0235	3300	1970	
21,000	1.073	1108	.5148	1.3937	69.70	3.610	.0395	.0238	3370	2030	
22,000	1.115	1144	.4974	1.4179	70.90	3.540	.0395	.0237	3420	2050	
23,000	1.158	1185	.4805	1.4426	72.13	3.490	.0396	.0234	3498	2060	
25,000	1.243	1263	.4480	1.4494	74.70	3.390	.0397	.0217	3600	1970	
30,000	1.463	1456	.3740	1.6352	81.76	3.220	.0400	.0188	3820	1800	
35,000	1.683	1638	.3098	1.7966	89.83	3.140	.0406	.0175	3970	1710	
40,000	1.885	1832	.2447	2.0215	101.08	3.160	.0415	.0168	4040	1640	
45,000	2.063	2003	.1926	2.2785	113.90	3.210	.0425	.0159	4000	1500	
50,000	2.255	2190	.1517	2.5675	128.40		.0439	.0151	4020	1380	

* Load = $\frac{\partial C_N(\alpha)}{\partial \alpha} \times q \times S$ S = 31.5 sq.ft.

AIRLOAD DISTRIBUTION ON BODY

(3000 lb Warhead)

Gust Condition

M = 1.16 Altitude 23,000 ft

- -

Body Load = 3498 lb (Ref. 115)

$\frac{X_B}{L}$ = .406 (Ref. 100)

Moment = 814,684 in/lb

<u>STA</u>	<u>LOAD</u>	<u>MOMENT</u>
0	17.1	0
40	152.6	6,104
80	170	13,600
120	252	3,024
160	428	68,480
200	629	125,800
240	661	158,640
280	635	177,800
320	503	160,960
360	264.1	95,076
400	13.0	5,200
440	0	-
480	0	-
520	0	-
560	0	-

For curve of airload distribution on missile body see page 98.

AIRLOAD DISTRIBUTION ON BODY

(3000 lb Warhead)

Maneuver Condition

M = 2.42 Altitude = 55,000 ft

- -

Body load = 19,194 lb (Ref pg. 113)
C.G. = Sta. 258 (Ref. pg. 100)
Moment = 4,951,969 in/lb

<u>STA</u>	<u>LOAD</u>	<u>MOMENT</u>
0	92	0
40	693	27,714
80	792	63,347
120	71	8,484
160	1,555	248,864
200	2,687	537,320
240	3,252	780,528
280	3,394	950,208
320	3,252	1,040,704
360	2,121	763,560
400	941	376,407
440	261	114,789
480	83	40,044
520	0	-
560	0	-

For curve of airload distribution on missile body see 98.

CONSOLIDATED VULTEE AIRCRAFT CORPORATION
 San Diego, California .

WEIGHT DISTRIBUTION

(3000 lb Warhead)

ITEM	W	X	WX	0	40	80	120	160
POWER PLANT	1,867		986,574					
BODY STRUCTURE	1,239		488,515					28
FIXED EQUIPMENT	395		203,550					
PAYLOAD	3,370	90.1	303,760	247.5	641.5	890.0	1191.0	400
PROPELLANTS	39,500		13,160,010					2543
TOTAL MISSILE	46,371	326.55	15,142,409	247.5	641.5	890.0	1191.0	2971

SECRET

SECRET

ION
 a)

STATION										
200	240	280	320	360	400	440	480	520	560	
							356.7	760.3	750.0	
91.0	84.0	84.0	130.8	31.2	276.0	184.0		177.4	152.6	
							153.1	135.0	106.9	
3502.0	4500.0	5300.0	5315.0	4400.0	4515.0	4335.0	4300.0	396.8	393.2	
3593.0	4584.0	5384.0	5445.8	4431.2	4791.0	4519.0	4809.8	1469.5	1402.7	

CONSOLIDATED VULTEE AIRCRAFT CORPORATION
San Diego, California

UNIT INERTIA SHEARS AND MOMENTS
(3000 lb Warhead)

1	2	3	4	5
STA. (x)	W	n = 1 S	ΔM	M
	Ref. pg. 118	Σ ②	③ x Δx	Σ ④
0	247.5	0		
40	641.5	247.5	9,900	9,900
80	890.0	889.0	35,560	45,460
120	1191.0	1779.0	71,160	116,620
160	2971.0	2970.0	118,800	235,420
200	3593.0	5941.0	237,640	473,060
240	4584.0	9534.0	381,360	854,420
280	5384.0	14,118.0	564,720	1,419,140
320	5445.8	19,502.0	780,080	2,199,220
360	4431.2	24,947.8	997,912	3,197,130
400	4791.0	29,379.0	1,175,160	4,372,290
440	4519.0	34,170.0	1,366,800	5,739,090
480	4809.8	38,689.0	1,547,560	7,286,650
520	1469.5	43,498.8	1,739,952	9,026,600
560	1402.7	44,968.3	1,798,732	10,825,330
		46,371.0	1,854,840	

M = $I \ddot{\alpha}$

For $\ddot{\alpha} = 1$

SECRET

SECRET

6	7	8	9	10
	$\ddot{\alpha} = 1$			
R	$\frac{WR}{g}$	S	ΔM	M
Ref. pg. 118 for c.g.	$\textcircled{2} \times \textcircled{6} \times$.002588	$\Sigma \textcircled{7}$	$\textcircled{8} \times \Delta R$	$\Sigma \textcircled{9}$
		0		
326.6	209.2			0
286.6	475.8	209.2	8,368	8,368
246.6	568.0	685.0	27,400	35,768
206.6	636.8	1253.0	50,120	85,888
166.6	1281.0	1889.8	75,592	161,480
126.6	1177.2	3170.8	126,832	288,312
86.6	1027.4	4348.0	173,920	462,232
46.6	649.3	5375.4	215,016	677,248
6.6	93.0	6024.7	240,988	918,236
-33.4	-383.0	6117.7	244,708	1,162,944
-73.4	-910.1	5734.7	229,388	1,392,332
-113.4	-1326.2	4824.6	192,984	1,585,316
-153.4	-1909.5	3498.4	139,936	1,725,252
-193.4	-735.5	1588.9	63,556	1,788,808
-233.4	-847.3	853.4	34,136	1,822,944
		0		

$I = \frac{1,822,944}{12} = 151,912 \text{ slug ft.}^2$

SHEAR & MOMENT
 (3000# WARHEAD) M = 2.42 ALT. 55,000 FT.

MANEUVER CONDITION

1	2	3	4	5	6	7	8	9	10	11
STA. (x)	AIR LOAD			n = -.6410		$\ddot{C} = +.60848$		TOTAL		
	ID.	S	ΔM	M	S	M	S	M	S	M
	Ref. Pg. 117	$\Sigma(2)$	$(3) \times \Delta x$	$\Sigma(4)$	$-.6410x$ Pg. 119 Col. 3	$-.6410x$ Pg. 119 Col. 5	$+.60848x$ Pg. 119 Col. 8	$+.60848x$ Pg. 119 Col. 10	$(3) + (8)$	$(5) + (9)$
0	92			0		0		00		0
40	693	92	3680	3680	-159	-6346	127	5092	6	0
80	792	785	31400	35080	-570	-29140	417	21764	632	27704
120	71	1577	63080	98160	-1140	-74753	762	52261	1199	75668
160	1555	1648	65920	164080	-1904	-150904	1150	98257	894	111433
200	2687	3203	128120	292200	-3808	-303231	1929	175432	1324	164401
240	3252	5890	235600	527800	-6111	-547683	2646	281259	2425	261376
280	3394	9142	365680	893480	-9050	-909669	3271	412092	3363	395903
320	3252	12536	501440	1394920	-12501	-1409700	3666	558728	3701	543948
360	2121	15788	631520	2026440	-15992	-2049362	3722	707268	3518	684346
400	941	17909	716360	2742800	-18832	-2802639	3489	847206	2566	787367
440	261	18850	754000	3496800	-21903	-3678758	2936	964633	-117	782675
480	83	19111	764440	4261240	-24800	-4670744	2129	1049781	-3560	640277
520	0	19194	767760	5029000	-27883	-5786053	967	1088454	-7722	331401
557.5	12454	19194	719775	5748775	-27883	-6867014	519	1107916	-8170	-10323
560	0	31648	79120	5827895	-29724	-6939040	519	1109225	-2443	-1920
561	-1924	31648	31648	5859543	-29724	-6968764	0	1109225	1924	0
		29724			-29724		0		0	
		$n = \frac{-29724}{46371} = -.6410$			$\ddot{C} = \frac{M}{I} = \frac{5859543 - 6968764}{12 \times 151912} = +.60848$					

ANALYSIS
 PREPARED BY
 CHECKED BY
 REVISED BY

CONSOLIDATED VULTEE AIRCRAFT CORPORATION

San Diego DIVISION

SECRET

PAGE 121
 REPORT NO. ZP-48-35003
 MODEL App. C
 DATE 11/23/48

I Sta. (x)	2	3	4	5	6	7	8	9	10	11	M = 1.16, Alt. 23000 Ft.	
											Total	M
SHEAR AND MOMENT												
3000# WARHEAD												
GUST CONDITION												
Air Load												
LD. Ref. Pg. 116												
		$\Sigma (2)$	$(3) \times \Delta M$	$\Sigma (4)$	$n = -1.643$	$\Sigma (5) \times 1.643$	$\Sigma (6) \times 1.643$	$\Sigma (7) \times 1.643$	$\Sigma (8) \times 1.643$	$\Sigma (9) \times 1.643$	$\Sigma (10) \times 1.643$	$\Sigma (11) \times 1.643$
0	17.1	0	0	0	0	0	0	0	0	0	0	0
40	152.6	17.1	684	684	40.7	1627	70.2	2808	2808	46.6	1865	1865
80	170.0	169.7	6788	7472	146.1	7469	229.9	12004	12004	253.5	12007	12007
120	25.2	339.7	13588	21060	292.3	19161	420.5	28824	28824	467.9	30723	30723
160	428.0	364.9	14596	35656	488.0	38680	634.2	54193	54193	511.1	51169	51169
200	629.0	792.9	31716	67372	976.1	77724	1064.1	96758	96758	880.9	86406	86406
240	661.0	1421.9	56876	124248	1566.4	140380	1459.2	155125	155125	1314.7	138993	138993
280	635.0	2082.9	83316	207564	2319.6	233160	1804.0	227284	227284	1567.3	201688	201688
320	503.0	2717.9	108716	316280	3204.2	361330	2021.9	308160	308160	1535.6	263110	263110
360	264.1	3220.9	128836	445116	4098.9	525290	2053.1	390284	390284	1175.1	310110	310110
400	13.0	3485.0	139400	584516	4827.0	718370	1924.6	467270	467270	582.6	333416	333416
440	0	3498.0	139920	724436	5614.1	942930	1619.1	532030	532030	-497.0	313536	313536
480	0	3498.0	139920	864356	6356.6	1197200	1174.1	579000	579000	-1684.5	246156	246156
520	0	3498.0	139920	1004276	7146.9	1499500	553.2	600300	600300	-3115.7	105076	105076
554.5	4120.0	3498.0	120681	1124957	7388.3	1754400	286.4	610180	610180	-3603.9	-19263	-19263
560	0	7618.0	41899	1166856	7388.3	1778600	286.4	611780	611780	+516.1	0	0
		7618.0		1166856	7618.8		0			0		

$n = \frac{7618}{46371} = -.1643$

$\ddot{\alpha} = M = - \frac{1166856 - 1778600}{12 \times 151912} = .3356$

SECRET

STRUCTURES

(3000 lb Warhead, 1000 mile Missile)

Propulsion and Operation Tanks

This section analyzes the propulsion and operation tanks used in the 3000 lb warhead rocket type missile.

The various tanks used, their general purpose and manner of loading are as follows:

HELIUM TANKS: These tanks serve to pressurize the fuel tank and to operate engine control valves. They are analyzed for internal pressure loads only.

HYDROGEN PEROXIDE TANKS: These tanks operate the pump turbines and are analyzed for internal pressure loads only.

ALCOHOL TANK: This fuel tank forms the body structure of the missile and is analyzed for body bending, axial and shear loads as well as for internal pressure loads.

OXYGEN TANK: This oxidizer fuel tank forms the body structure also and is analyzed for body bending, axial and shear loads as well as for internal pressure loads.

One or more of the above type tanks are utilized as explained below.

Two spherical helium tanks are used. The tank supplying the pressurization for the fuel tank dropping off with the booster stage.

Working pressure	= 2,000 psi
Yield pressure	= 1.25 (2,000) = 2,500 psi
Radius, R	= 11 inches
Thickness, t	= 0.125 inches (Allow an .80 reduction factor for thinning out of material due to forming)

Material = 4130 steel sheet

F_{tu} = 150,000 psi

F_{ty} = 135,000 psi

$$f_{ty} = \frac{2,500 (11)}{2(.125)(.8)} = 135,000 \text{ psi}$$

$$\text{M.S.} = \frac{135,000}{135,000} - 1 = \underline{0.0}$$

The spherical tank is formed by welded butt joints as shown in the accompanying sketch. The 0.109 gage steel sheet doublers are welded to the tank spherical sections which are then butt-welded together.

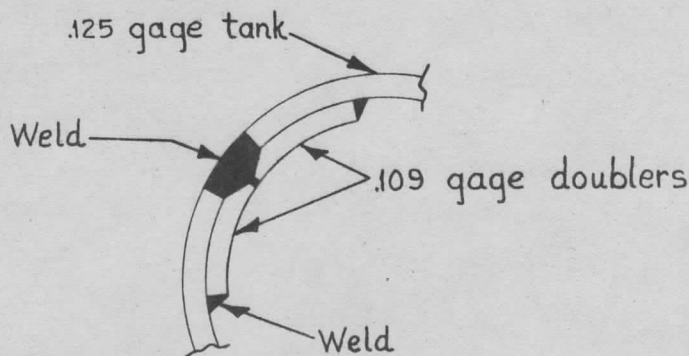

F_{ty} at weld = 60,000 psi

$$f_{ty} = \frac{2,500 (11)}{2(.125+.109)} = 58,700 \text{ psi}$$

$$\text{M.S.} = \frac{60,000}{58,700} - 1 = \underline{+.02}$$

The second spherical helium tank operates the engine controls.

Working pressure = 2,000 psi
 Yield pressure = 1.25 (2,000) = 2,500 psi
 Radius, R = 5 inches
 Thickness, t = 0.062 inches (Allow an .80 reduction factor for thinning out of material due to forming)

Material = same as above

$$f_{ty} = \frac{2,500 (5)}{2(.062)(.8)} = 127,000 \text{ psi}$$

$$\text{M.S.} = \frac{135,000}{127,000} - 1 = \underline{+.06}$$

Welded butt joints are used in forming the spherical section as described above.

t (of doubler) = 0.062 inches

$$f_{ty} = \frac{2,500 (5)}{2(.062-.062)} = 50,400 \text{ psi}$$

$$\text{M.S.} = \frac{60,000}{50,400} - 1 = \underline{+.19}$$

Two hydrogen peroxide tanks are used. The first tank separating from the missile with the booster stage. The first tank is formed by two spherical ends of radius 12 inches connected by a 3 inch cylinder.

Working pressure = 450 psi
Yield pressure = 1.25 (450) = 563 psi
Radius, R = 12 inches
Length, l = 3 inches
Thickness of spherical ends, t = 0.125 inches) \rightarrow Allow an .80
Thickness of cylinder, t = 0.250 inches) reduction factor
for thinning out
of material due
to forming.

Material = 61 ST, $F_{ty} = 35,000 \text{ psi}$

$$f_{ty} (\text{spherical ends}) = \frac{563(12)}{2(.125)(.8)} = 33,800 \text{ psi}$$

$$\text{M.S.} = \frac{35,000}{33,800} - 1 = \underline{+.035}$$

$$f_{ty} (\text{cylinder}) = \frac{563 (12)}{.25} = 27,000 \text{ psi}$$

$$\text{M.S.} = \frac{35,000}{27,000} - 1 = \underline{+.30}$$

The spherical ends and 3 inch cylinder are welded together with butt joints as shown in the sketch on page 123.

Thickness of doublers, t = 0.250 inches

F_{ty} at weld = 9,000 psi

$$f_{ty} = \frac{563 (12)}{2(.125 + .250)} = 9,000 \text{ psi}$$

$$\text{M.S.} = \frac{9,000}{9,000} - 1 = \underline{0.0}$$

The second hydrogen peroxide tank is a spherical shape.

Working pressure = 450 psi
Yield pressure = 1.25 (450) = 563 psi
Radius, R = 12 inches
Thickness, t = 0.125 inches (Allow an .80 reduction factor for thinning out of material due to forming)

Material = 61 ST, F_{ty} = 35,000 psi

$$f_{ty} = \frac{563(12)}{2(.125)(.8)} = 33,800 \text{ psi}$$

$$\text{M.S.} = \frac{35,000}{33,800} - 1 = \underline{+.035}$$

The spherical section is formed by butt welding as shown in the sketch on page 123.

Thickness of doublers, t = 0.250 inches

F_{ty} at weld = 9,000 psi

$$f_{ty} = \frac{563 (12)}{2(.125 + .250)} = 9,000 \text{ psi}$$

$$\text{M.S.} = \frac{9,000}{9,000} - 1 = \underline{0.0}$$

The alcohol tank is critical at body station 470. The section will be checked for the maximum body bending moment and axial load, and internal pressure existing at 55,000 ft altitude.

$$\text{B.M.} = 787,400 \text{ in.lb. (Ref. page 120)}$$

The axial load will be computed as follows:

$$\text{Thrust} = 78,000 \text{ lb}$$

$$\text{Weight of missile at 55,000 ft altitude} = 28,335 \text{ lb}$$

$$\text{Drag inertia load factor} = \frac{78,000}{28,335} = 2.75$$

$$\begin{aligned} \text{Weight of inertia items aft of station 470 not including fuel} \\ = 2,592 \text{ lb.} \end{aligned}$$

$$\begin{aligned} \text{Weight of hydrogen peroxide aft of station 470} &= 223 \text{ lb} \\ \text{Weight of alcohol in aft tank} &= 4,842 \text{ lb} \\ \text{Therefore, total weight at station 470} &= 28,335 - \\ & 2,592 - 223 - 4,842 = 20,678 \text{ lb.} \end{aligned}$$

$$\text{Then, axial load at station 470} = 2.75 (20,678) = 57,000 \text{ lb.}$$

$$\text{Internal pressure} = 20 \text{ psi}$$

This critical section is an 0.072 in. thick circular cylinder of radius 37.98 inches. The material is 61 ST sheet, $F_{ty} = 35,000 \text{ psi}$

$$f_c = \frac{\text{B.M.}}{\pi R^2 t} + \frac{P}{A}$$

$$\begin{aligned} f_c &= \frac{787,400}{\pi (37.98)^2 (.072)} + \frac{57,000}{2(\pi)(37.98)(.072)} \\ &= 5,740 \text{ psi} \end{aligned}$$

$$\begin{aligned} f_t &= \frac{20(37.98)}{2(.072)} \\ \text{(due to internal pressure)} \\ &= 5,280 \text{ psi} \end{aligned}$$

$$\begin{aligned} \text{Resulting } f_c &= 5,740-5,280 \\ &= 460 \text{ psi} \end{aligned}$$

$$\frac{r}{t} = \frac{37.98}{.072} = 527$$

$$K_c = .00036 \quad (\text{Ref. Technical Note No. 479, Fig. 5})$$

$$F_c = EK_c = 10,000,000 (.00036) = 3,600 \text{ psi}$$

Therefore, M. S. is ample

The tank is formed by use of 61 ST doublers butt-welded together as shown in the sketch on page 123.

$$\text{Static internal yield pressure} = 60 \text{ psi}$$

$$f_{ty} = \frac{60(37.98)}{(.072)} = 31,700 \text{ psi}$$

$$\text{M.S.} = \frac{35,000}{31,700} - 1 = \underline{+.10}$$

$$\text{Thickness of doublers at weld, } t = 0.188 \text{ inches}$$

$$f_{ty} = \frac{60(37.98)}{(.072+.188)} = 8,770 \text{ psi}$$

$$F_{ty} \text{ at weld} = 9,000 \text{ psi}$$

$$\text{M.S.} = \frac{9,000}{8,770} - 1 = \underline{+.025}$$

The oxygen tank is critical at body station 170. The section will be checked for the existing body bending moment and axial load and internal pressure.

$$\text{B.M.} = 124,700 \text{ in.lb.} \quad (\text{Ref. page 120})$$

The axial load will be computed as follows:

$$\text{Thrust} = 78,000 \text{ lb.}$$

$$\text{Weight of missile at 55,000 ft altitude} = 28,335 \text{ lb.}$$

$$\text{Drag inertia load factor} = \frac{78,000}{28,335} = 2.75$$

Weight of inertia items aft of station 170 not including fuel
= 3,501 lb.

Weight of hydrogen peroxide aft of station 170 = 223 lb.

Weight of alcohol in aft tank = 4,842 lb.

Weight of oxygen in forward tank = 6,100 lb.

Therefore, total weight at station 170 = 28,335 - 3,501 -
223 - 4,842 - 6,100 = 13,669 lb.

Then axial load at station 170 = 2.75 (13,669) = 37,600 lb.

Internal pressure = 20 psi

The critical section is an 0.072 inch thick circular cylinder
of radius 21.96 inches. The material is 61 ST sheet, $F_{ty} = 35,000$ psi.

$$f_c = \frac{B.M.}{\pi R^2 t} + \frac{P}{A}$$

$$= \frac{124,700}{\pi (21.96)^2 (.072)} + \frac{37,600}{2(\pi)(21.96)(.072)}$$

$$= 4,920 \text{ psi}$$

$$f_t = \frac{20(21.96)}{2(.072)}$$

(due to internal pressure)

$$= 3,050 \text{ psi}$$

$$\text{resulting } f_c = 4,920 - 3,050$$

$$= 1,870 \text{ psi}$$

$$\frac{r}{t} = \frac{21.96}{.072} = 305$$

$$K_c = 0.0005 \text{ (Ref. Technical Note No. 479, Fig. 5)}$$

$$F_c = EK_c = 10,000,000 (.0005) = 5,000 \text{ psi}$$

Therefore, M. S. is ample.

ANALYSIS
PREPARED BY
CHECKED BY
REVISED BY

CONSOLIDATED VULTEE AIRCRAFT CORPORATION

San Diego DIVISION

SECRET

PAGE 129
REPORT NO ZP-48-35003
MODEL Appendix C
DATE NOV. 23, 1948

The tank is formed by use of 61 ST doublers butt-welded together as shown in the sketch on page 123.

Static internal pressure = 60 psi

Thickness of tank cylinder, $t = 0.072$ inches

Thickness of doublers at weld, $t = 0.188$ inches

Least M. S. (Ref. page 127) = +0.025

PERFORMANCE ANALYSIS

(3000 Pound Warhead, 1000 Mile Missile)

A. GENERAL

The 3000 pound warhead, 1000 mile missile operates in two stages, the first stage or booster stage and a final stage. During the booster stage the missile is powered by three 20,000 pound thrust rocket motors and four 2,000 pound thrust rocket motors. At the end of the booster stage two of the 20,000 pound thrust rockets are ejected from the missile along with related equipment, a portion of the fins and a segment of the skin and structure of the aft part of the missile. The final stage then carries on to the end of burning, powered by one 20,000 pound thrust rocket motor and four 2,000 pound thrust rocket motors.

B. RANGE ANALYSIS

The range problem is divided into two parts, the powered flight and the elliptical orbit from fuel cut-off to the point of impact.

During the powered flight phase the performance was calculated by the following method:

V_z = vertical component of velocity at end of burning

$$= (I_1 g \log_e m_1 + I_2 g \log_e m_2) \sin \theta - g(t_1 + t_2)$$

V_x = horizontal component of velocity at end of burning

$$= (I_1 g \log_e m_1 + I_2 g \log_e m_2) \cos \theta$$

V = Velocity along the flight path

$$= \sqrt{V_z^2 + V_x^2}$$

S_z = vertical component of distance at the end of burning

$$= \left[\frac{I_1^2 g}{a_1} \left(1 - \frac{1}{m} - \frac{\log_e m_1}{m_1} \right) + \frac{I_2^2 g}{a_2} \left(1 - \frac{1}{m_2} - \frac{\log_e m_2}{m_2} \right) \right] \sin \theta + V_z t_2$$

$$- \frac{1}{2} g (t_1 + t_2)^2$$

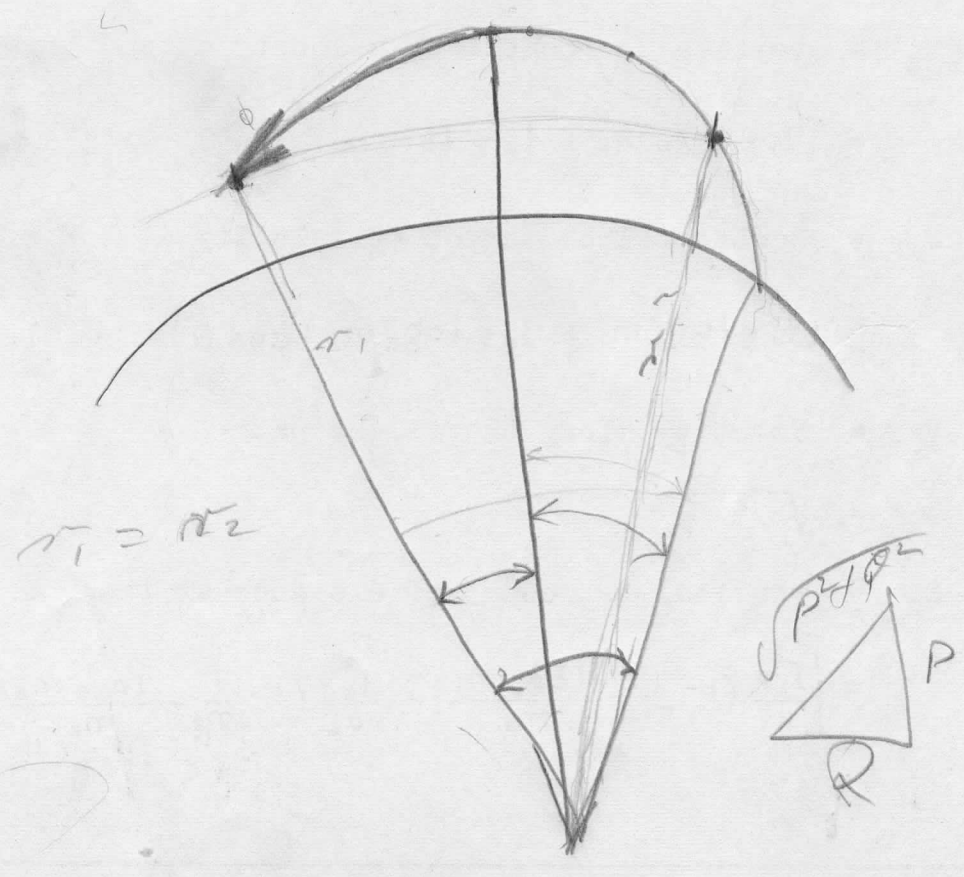

S_x = horizontal component of distance at the end of burning
 $= \left[\frac{I_1^2 g}{a_1} \left(1 - \frac{1}{m_1} - \frac{\log_e m_1}{m_1} \right) + \frac{I_2^2 g}{a_2} \left(1 - \frac{1}{m_2} - \frac{\log_e m_2}{m_2} \right) \right] \cos \theta + V_x t_2$
 γ = flight path angle with respect to the tangent to the earth below the missile at end of burning

$$= \tan^{-1} \frac{V_x}{V_z} + \tan^{-1} \frac{S_x}{r_0}$$

I = Specific Impulse

a = Initial Acceleration

m = Mass Ratio

θ = Missile Attitude

t = time of flight

r_0 = Radius of earth

The subscripts 1 and 2 used above indicate the conditions for the booster stage and final stage respectively.

During the elliptical flight path from the end of burning to the point of impact on the earth's surface and given the above conditions, the range may be determined by the following relationship.

R_e = Range of the elliptical flight path phase

$$= \frac{\theta_{R_2}}{57.3} r_0$$

where $\theta_{R_2} = \cos^{-1} \frac{B}{\sqrt{P^2 + Q^2}} + \tan^{-1} \frac{P}{Q} = \cos^{-1} \frac{B}{\sqrt{P^2 + Q^2}} + \cos^{-1} \frac{Q}{\sqrt{P^2 + Q^2}}$

$$P = \frac{1}{2} \sin 2\gamma$$

$$\gamma = \phi$$

[Handwritten scribbles and annotations]

$$\frac{ft \quad ft^2}{ft^3/arc}$$



$$Q = \frac{1}{A} - \cos^2 \gamma$$

$$B = \frac{1}{A} - \cos^2 \gamma \left(\frac{r_1}{r_0} \right)$$

$$A = \frac{r_1 V^2}{4}$$

r_0 = radius of earth = 3963 miles

$$r_1 = r_0 + S_z$$

$$r_2 = r_0 + \text{ALT at Target}$$

$$4 = g r_0^2$$

the total range now becomes

$$R = S_x + R_e$$

Previous investigations show that the effect of drag may be accounted for in this method by omitting the increase of thrust with altitude in the booster stage.

A series of investigations were conducted to ascertain as closely as possible the best fuel distribution between the two stages to obtain the optimum range. Using these results, the performance of the 3,000 pound warhead, 1000 mile missile was calculated. A summary of these results are presented below.

PERFORMANCE

Staging Conditions

	Booster Stage (I)		Final Stage (II)	
Weight Full	46,261	lbs	19,533	lbs
Weight Empty	6,761	lbs	5,633	lbs
Weight of Fuel (Total)	39,500	lbs	13,900	lbs
Thrust at S.L.	68,000	lbs	28,000	lbs
Specific Impulse at S.L.	210	sec	210	sec
Fuel Consumption	324	#/sec	133.5	#/sec
Mass Ratio	2.25	**	3.62	*
Initial Acceleration	1.47		1.63	
Time of Burning	79.06	sec	104.19	sec

* Corrected for thrust at altitude

** Mass ratio Booster Stage (I) = $\frac{\text{weight full}}{\text{weight empty} + \text{Stage II fuel}}$

PERFORMANCE SUMMARY

	Performance at end of booster stage	Performance at end of final stage
Velocity along flight path	5470 ft/sec.	15210 ft/sec.
S _z - Altitude	6.02 miles	52.77 miles
S _x - Range	25.09 miles	155.17 miles
θ - Attitude Angle	45.0°	45.0°

Maximum Altitude = 170 miles

Total Range = 1042 miles

~~SECRET~~
ROCKET TYPE MISSILE
(3000 LB WARHEAD-1000 MI)

DRAG COEFFICIENT AS A FUNCTION OF MACH NUMBER

$C_D = D/qS_B$
D = DRAG OF MISSILE
q = DYNAMIC PRESSURE
 S_B = MAX. BODY CROSS SECTION
AREA = 31.5 SQ FT

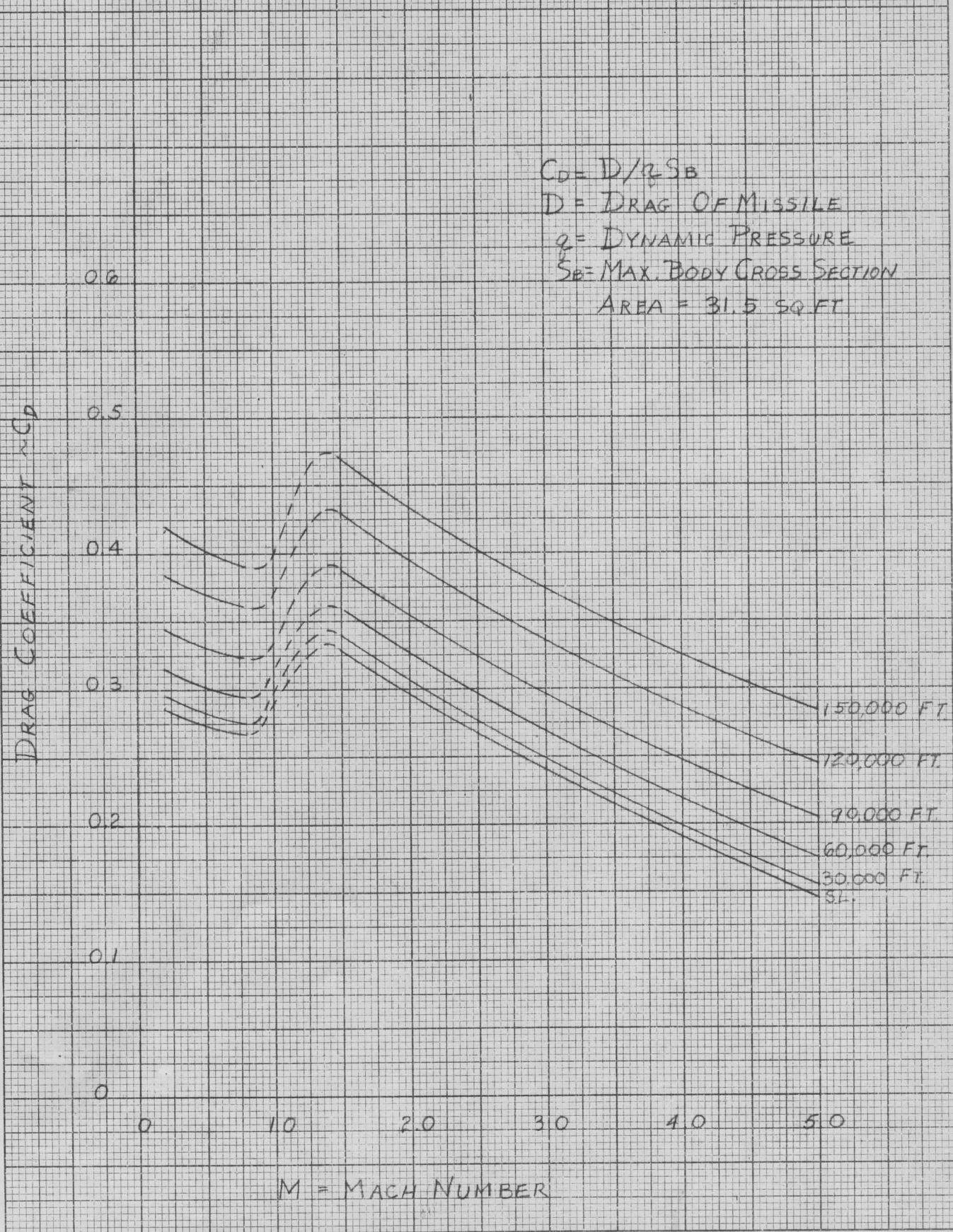

NO. 323-11 10 x 10 to the first inch, 2 1/2 inch squares accounted.
MADE IN U.S.A.
Engraving, 1 x 10 in.

PERF 3000
KEMPFF & ESSER CO.

3000 LB WARHEAD

WARHEAD EJECTION MECHANISM

LIQU

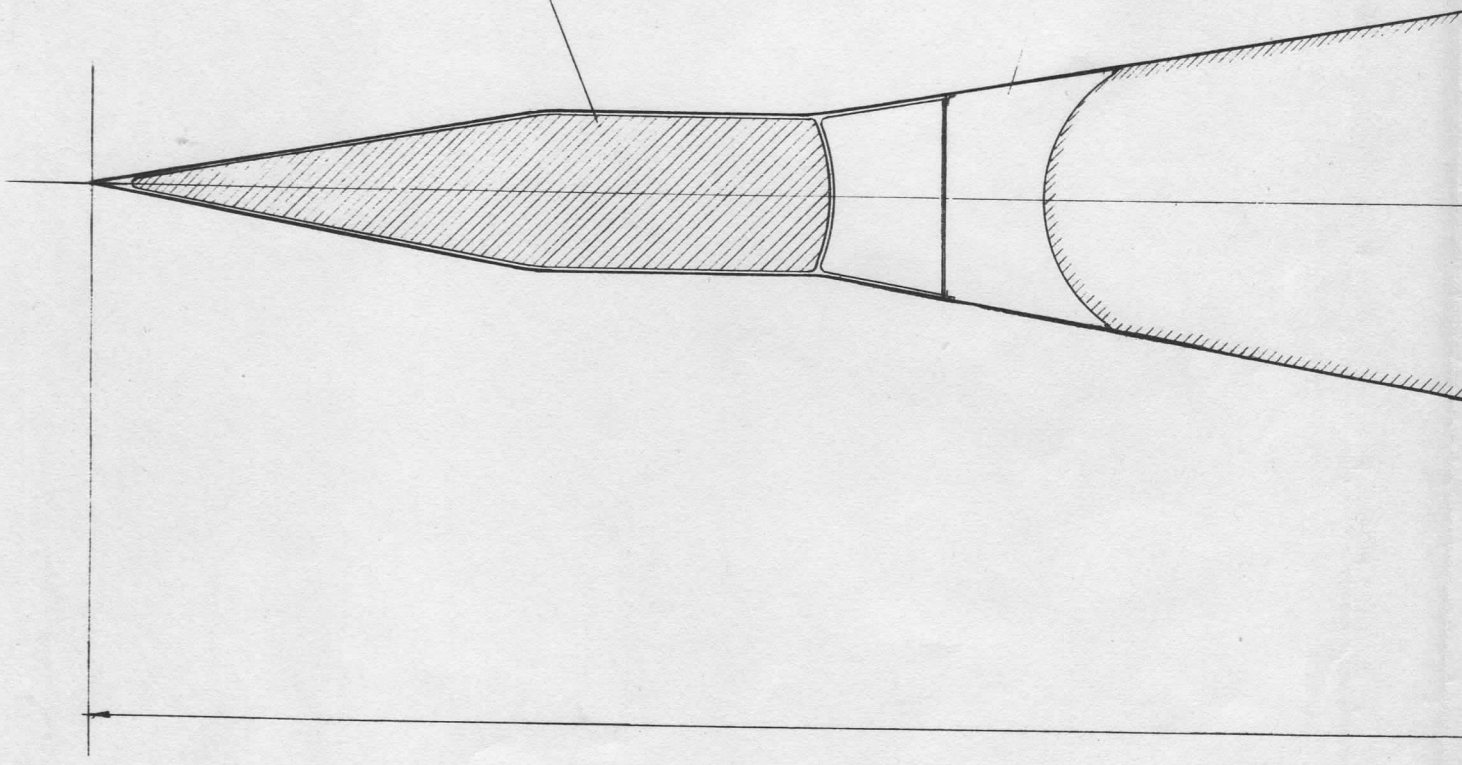

OXYGEN TANK

ALCOHOL TANK

2ND STAGE PU

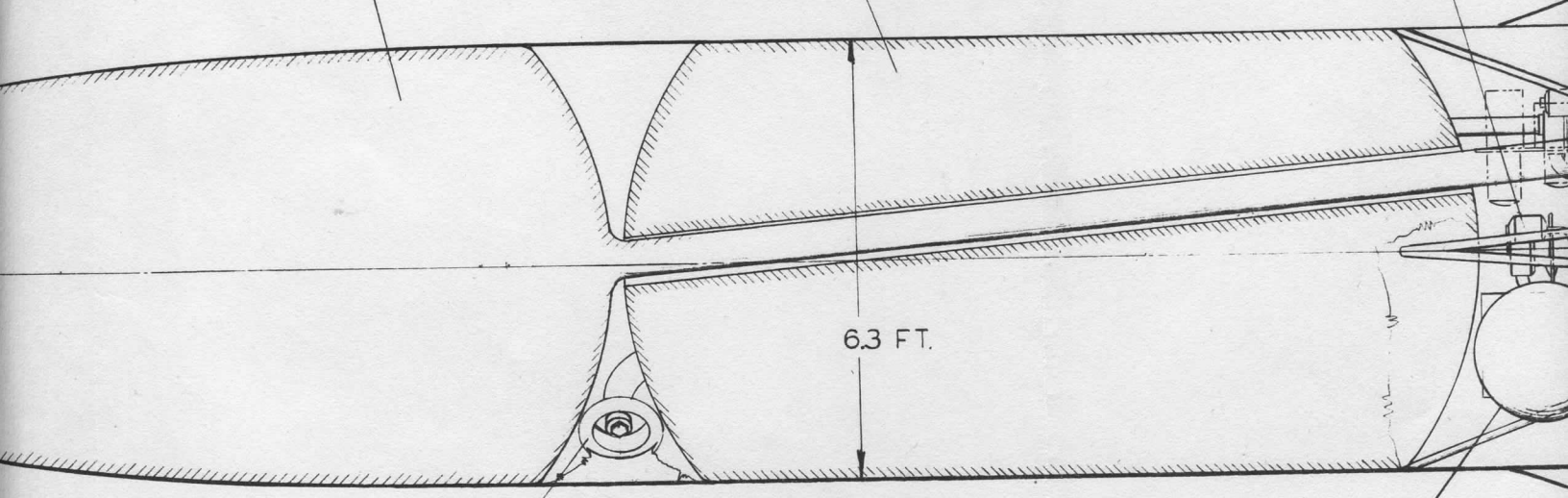

6.3 FT.

ALCOHOL FILLER

2ND STAGE H₂O₂ TANK

HELIUM TANK
FOR CONTROL OPI

49.66 FT.

MP

1ST STAGE PUMP
(JETTISONED)

BREAK LINE

SKIRT
(JETTISONED)

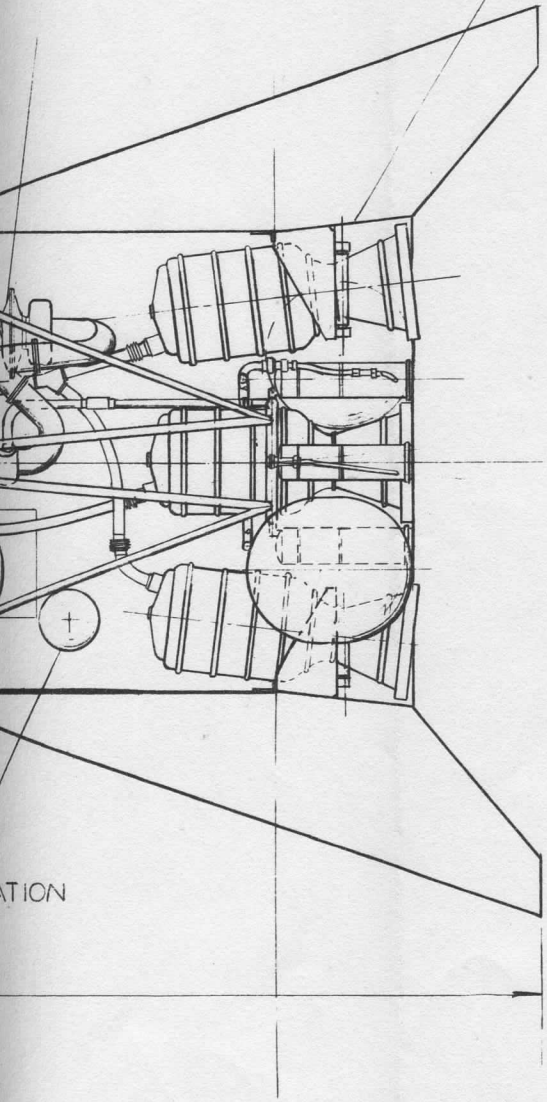

STABILIZATION

1-20000 THRUST ENGINE

4-2000 LB THRUST
SWIVELING ENGINES

1ST STAGE H₂O₂ TANK
(JETTISONED)

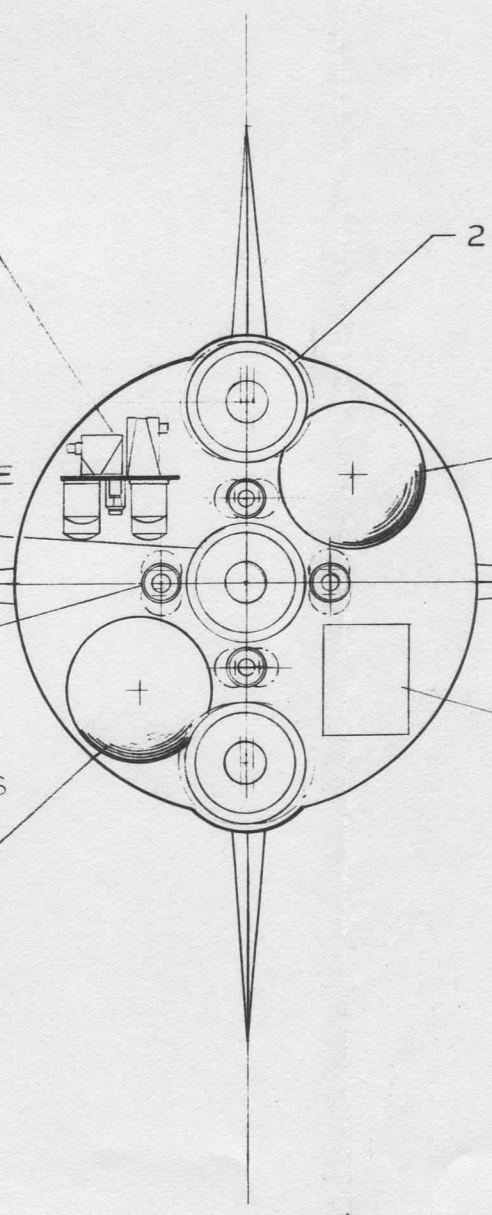

2 20 000
JE

1ST.

GUIDA

ATION

Convair

PRELIMINARY

1000 MILE RO
3000

BY H. ALGER. | CHECKED

CONSOLIDATED VULTEE A
SAN DIEGO

SKIRT
(JETTISONED)

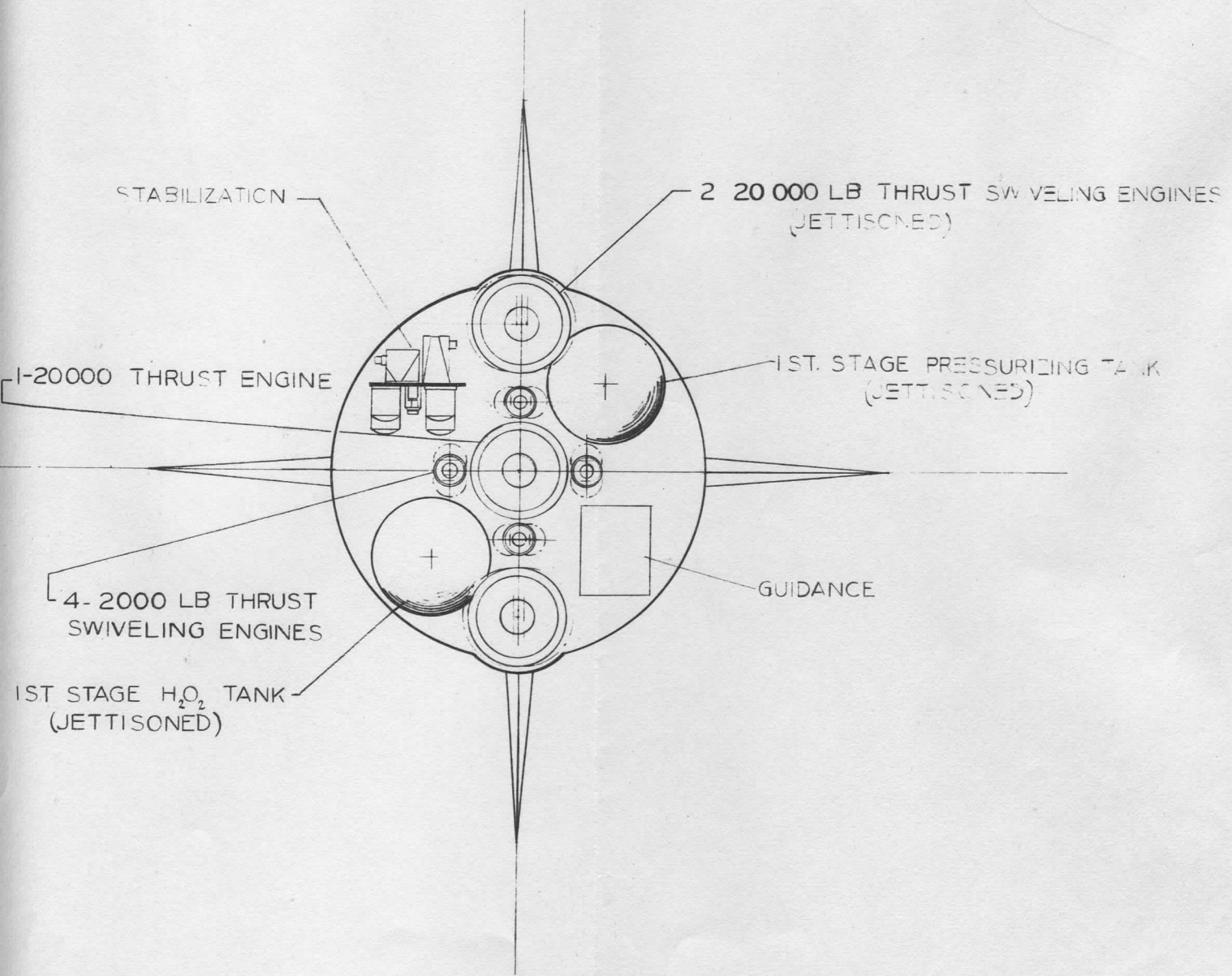

Convair SECRET

PRELIMINARY DESIGN DRAWING

1000 MILE ROCKET TYPE MISSILE 3000 LB WARHEAD			
BY H. ALGER	CHECKED <i>ca</i>	APPROVED <i>ca</i>	SCALE ONE SIXTEENTH
CONSOLIDATED VULTEE AIRCRAFT CORPORATION SAN DIEGO CALIFORNIA			DATE 11/24/46 SD 48-35002

SECRET

SECRET

SECRET